

Mini HI-FI Component System

Operating Instructions

Owner's Record

The model and serial numbers are located on the rear of the unit. Record these numbers in the space provided below. Refer to them whenever you call upon your Sony dealer regarding this product.

Model No. _____ Serial No. _____



***MHC-GX470
MHC-RG590S/RG490S/RG290/
RG190***

WARNING

To reduce the risk of fire or electric shock, do not expose this apparatus to rain or moisture.

To reduce the risk of fire, do not cover the ventilation of the apparatus with newspapers, tablecloths, curtains, etc. And do not place lighted candles on the apparatus.

To reduce the risk of fire or electric shock, do not place objects filled with liquids, such as vases, on the apparatus.

Connect the unit to an easily accessible AC outlet. Should you notice an abnormality in the unit, disconnect the main plug from the AC outlet immediately.

Do not install the appliance in a confined space, such as a bookcase or built-in cabinet.

CAUTION

The use of optical instruments with this product will increase eye hazard.

Except for customers in the U.S.A and Canada

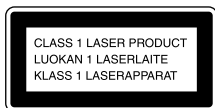

This appliance is classified as a CLASS 1 LASER product. This marking is located on the rear exterior.

Notice for the customers in the U.S.A

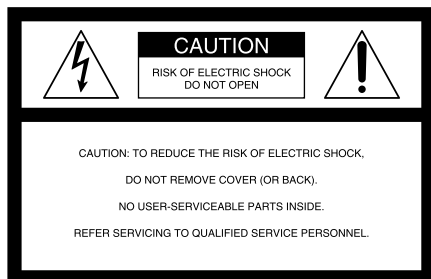

This symbol is intended to alert the user to the presence of uninsulated “dangerous voltage” within the product’s enclosure that may be of sufficient magnitude to constitute a risk of electric shock to persons.



This symbol is intended to alert the user to the presence of important operating and maintenance (servicing) instructions in the literature accompanying the appliance.

WARNING

This equipment has been tested and found to comply with the limits for a Class B digital device, pursuant to Part 15 of the FCC Rules. These limits are designed to provide reasonable protection against harmful interference in a residential installation. This equipment generates, uses, and can radiate radio frequency energy and, if not installed and used in accordance with the instructions, may cause harmful interference to radio communications. However, there is no guarantee that interference will not occur in a particular installation. If this equipment does cause harmful interference to radio or television reception, which can be determined by turning the equipment off and on, the user is encouraged to try to correct the interference by one or more of the following measures:

- Reorient or relocate the receiving antenna.
- Increase the separation between the equipment and receiver.
- Connect the equipment into an outlet on a circuit different from that to which the receiver is connected.
- Consult the dealer or an experienced radio/TV technician for help.

This device complies with Part 15 of the FCC Rules. Operation is subject to the following two conditions:

- (1) this device may not cause harmful interference, and
- (2) this device must accept any interference received, including interference that may cause undesired operation.

You are cautioned that any changes or modifications not expressly approved in this manual could void your authority to operate this equipment.

Note to CATV system installer:

This reminder is provided to call the CATV system installer's attention to Article 820-40 of the NEC that provides guidelines for proper grounding and, in particular, specifies that the cable ground shall be connected to the grounding system of the building, as close to the point of cable entry as practical.



Disposal of Old Electrical & Electronic Equipment (Applicable in the European Union and other European countries with separate collection systems)

This symbol on the product or on its packaging indicates that this product shall not be treated as household waste. Instead it shall be handed over to the applicable collection point for the recycling of electrical and electronic equipment. By ensuring this product is disposed of correctly, you will help prevent potential negative consequences for the environment and human health, which could otherwise be caused by inappropriate waste handling of this product. The recycling of materials will help to conserve natural resources. For more detailed information about recycling of this product, please contact your local Civic Office, your household waste disposal service or the shop where you purchased the product.

Applicable accessories: Remote commander

U.S.A., Canadian and Australian models only



ENERGY STAR® is a U.S. registered mark. As an ENERGY STAR® partner, Sony Corporation has determined that this product meets the ENERGY STAR® guidelines for energy efficiency.

Note on DualDiscs

A DualDisc is a two sided disc product which mates DVD recorded material on one side with digital audio material on the other side. However, since the audio material side does not conform to the Compact Disc (CD) standard, playback on this product is not guaranteed.

Music discs encoded with copyright protection technologies

This product is designed to playback discs that conform to the Compact Disc (CD) standard. Recently, various music discs encoded with copyright protection technologies are marketed by some record companies. Please be aware that among those discs, there are some that do not conform to the CD standard and may not be playable by this product.

MPEG Layer-3 audio coding technology and patents licensed from Fraunhofer IIS and Thomson.

Table of Contents

Guide to parts and controls 5

Getting Started

Hooking up the system securely 8
Setting the clock 10

Basic Operations

Playing a CD/CD-G/MP3 disc 11
Listening to the radio 12
Playing a tape 13
Using optional audio components... 14
Adjusting the sound 14
Changing the display 15

Other Operations

Creating your own CD program
(Program Play) 16
Presetting radio stations 17
Recording onto a tape
(CD Synchro recording/Manual
recording/Sound Mixing) 18
Creating your own sound effect 19
Enjoying karaoke
(Latin American model only) 20
Using the Timers 21

Others

Troubleshooting 23
Messages 25
Precautions 26
Specifications 27

Guide to parts and controls

Unit

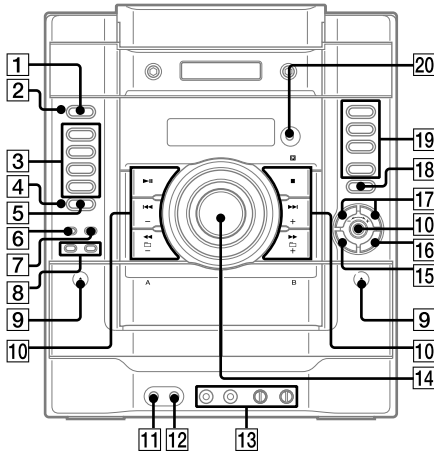

This manual mainly explains operations using the remote, but the same operations can also be performed using the buttons on the unit having the same or similar names.

1 I/⏻ (power) button (page 10, 21, 24)
Press to turn on the system.

2 STANDBY indicator (page 15, 23)
Lights up when the system is turned off.

3 CD button (page 11)
Press to select the CD function.

TUNER/BAND button (page 12)
Press to select the TUNER function. Press to select FM or AM reception mode.

Unit: TAPE A/B button (page 13)
Remote: TAPE button (page 13)
Press to select the TAPE function. Press to select TAPE A or TAPE B.

AUDIO IN button (page 14)
Press to select the AUDIO IN function.

FUNCTION button
Press to select the function.







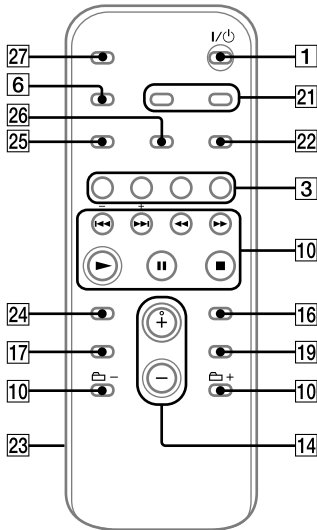



4 SUBWOOFER indicator (MHC-GX470/RG590S/RG490S only) (page 14)
Lights up when the subwoofer is turned on.

5 SUBWOOFER button (MHC-GX470/RG590S/RG490S only) (page 14)
Press to turn on and off the subwoofer.

Remote



Continued

- 6** Mexican model:
 Unit: KARAOKE button (page 20)
 Press to activate the karaoke mode.
 Remote: DISPLAY button (page 15)
 Press to change the information on the display.
- Other models:
 DISPLAY button (page 15)
 Press to change the information on the display.
- 7** North American model:
 PLAY MODE/TUNING MODE button (page 11, 12, 13)
 Press to select the play mode of a CD, MP3 or tape. Press to select the tuning mode.
- Other models:
 ILLUMINATION button (page 15)
 Press to change the illumination pattern around the VOLUME control **14**.
- 8** Buttons for synchro recording or manual recording (page 18)
 REC PAUSE/START button,
 CD SYNC button
 Press to record on a tape.
- 9** PUSH  button (page 13)
 Press to insert or eject a tape.
- 10** Playback buttons (page 11, 12, 13)
 Unit:   (play/pause) button
 Remote:  (play) button,
 (pause) button
 Press to start or pause playback.
-  (stop) button (page 11, 12, 13)
 Press to stop playback.
-  (go back/go forward) button (page 11)
 Press to select a track or file.
- Unit: TUNING +/- button (page 12)
 Remote: +/- (tuning) button (page 12)
 Press to tune in the desired station.
-  +/- (select folder) button (page 11)
 Press to select a folder on an MP3 disc.
-  (rewind/fast forward) button (page 11, 13)
 Press to find a point in a track or file.
- MULTI JOG dial ( (go back/go forward), +/- (tuning)) (page 11, 19)
 Turn to select a track or file. Turn to tune in the desired station. (Same as the , +/- buttons on the remote)
- 11** PHONES jack
 Connect the headphones.
- 12** AUDIO IN jack (page 14)
 Connect to an audio component.

- 13** Latin American model only:
MIC jack (page 20)
 Connect the microphone. Mexican model comes with 2 microphone jacks.
MIC LEVEL (page 20)
 Turn to adjust the microphone volume.
- Mexican model only:**
ECHO LEVEL (page 20)
 Turn to adjust the echo level.
- 14** Unit: **VOLUME control (page 11, 12, 13, 14)**
 Turn to adjust the volume.
- Remote: VOLUME +/- button (page 11, 12, 13, 14)**
 Press to adjust the volume.
- 15** **EQ BAND button (page 19)**
 Press to select the frequency band.
- 16** **ENTER button (page 10, 16, 17, 21)**
 Press to enter the settings.
- 17** **Sound buttons (page 14, 19)**
 Unit: **GROOVE button, SURROUND button**
 Remote: **EQ button**
 Press to select the sound.
- 18** **⏏ (open/close) button (page 11)**
 Press to insert and eject a disc.
- 19** **DISC 1 – 3 button (page 11)**
 Press to select a disc. Press to switch to the CD function from other function.
- Unit: DISC SKIP/EX-CHANGE button (page 11)**
 Press to select a disc. Press to exchange a disc while playing.
Remote: DISC SKIP button (page 11)
 Press to select a disc.
- 20** **Remote sensor (page 23)**
- 21** **CLOCK/TIMER SELECT button (page 21)**
CLOCK/TIMER SET button (page 10, 21)
 Press to set the clock and the timers.
- 22** **REPEAT/FM MODE button (page 11, 12)**
 Press to listen to a disc, a single track or file repeatedly. Press to select the FM reception mode (monaural or stereo).
- 23** **Battery compartment lid (page 10)**
- 24** **CLEAR button (page 16)**
 Press to delete a pre-programmed track.
- 25** **TUNER MEMORY button (page 17)**
 Press to preset the radio station.
- 26** **PLAY MODE/TUNING MODE button (page 11, 12, 13)**
 Press to select the play mode of a CD, MP3 or tape.
 Press to select the tuning mode.
- 27** **SLEEP button (page 21)**
 Press to set the Sleep Timer.

Getting Started

Hooking up the system securely

When carrying this system

- 1 Remove all discs to protect the CD mechanism.
- 2 Press CD **3** to select the CD function.
- 3 Hold down **▶|| 10** on the unit, and press **I/⏻ 1** on the unit until "STANDBY" appears.
- 4 After "LOCK" appears, unplug the power cord.

Subwoofer (MHC-GX470/RG590S/ RG490S only)

Place the subwoofer vertically to obtain a better bass reproduction. Also, position the subwoofer:

- on a solid floor where resonance is unlikely to occur.
- at least a few centimeters away from the wall.
- away from the center of the room or place a bookshelf against a wall, to avoid generating a standing wave.

Speakers and subwoofer

Attach the supplied speaker pads to the bottom of the front speakers and subwoofer to prevent slipping.

Front speaker for all models, Subwoofer for MHC-GX470/RG490S

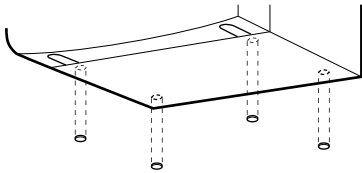

Subwoofer for MHC-RG590S

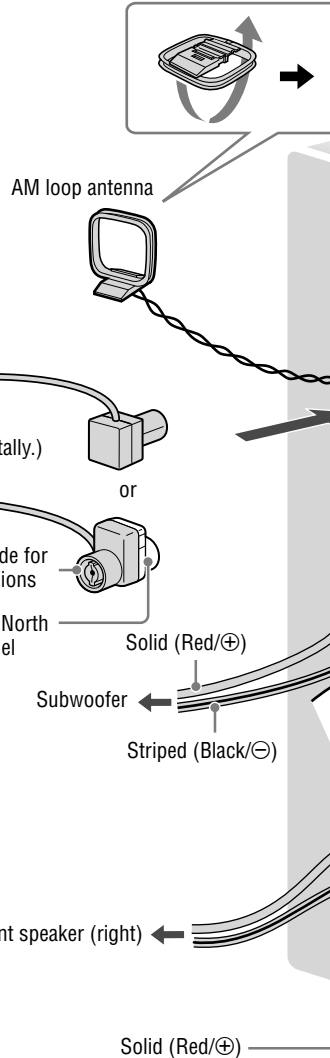
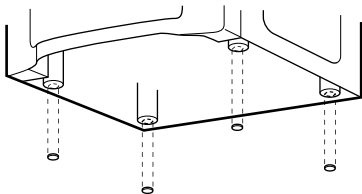

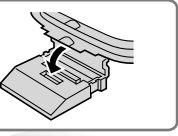

Antennas

Find a location and an orientation that provide good reception, and then set up the antenna. Keep the antennas away from the speaker cords to avoid picking up noise.

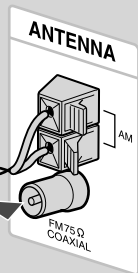

Speakers and subwoofer

Insert only the stripped portion of the cord.

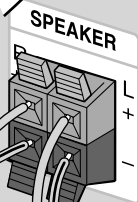

Video cable (supplied)

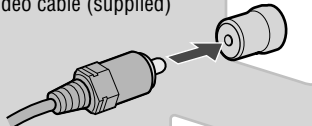

Striped (Black/⊖)

Front speaker (left)

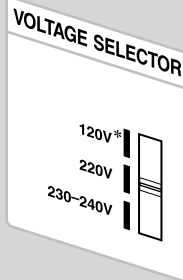

Wall socket



Video (Mexican model only)

To view video from this system, turn on the TV, and select the appropriate video input on the TV. The Mexican model can play back only NTSC-format CD-G discs.

Power

For models with a voltage selector, set VOLTAGE SELECTOR to the local power line voltage.

Connect the power cord to a wall socket. The demonstration appears in the display.

If the plug does not fit the wall socket, detach the supplied plug adaptor (only for models equipped with an adaptor).

* Saudi Arabian model: 120 – 127 V

Continued 

To use the remote

Slide and remove the battery compartment lid **[23]**, and insert the two supplied R6 (size AA) batteries, **+** side first, matching the polarities shown below.

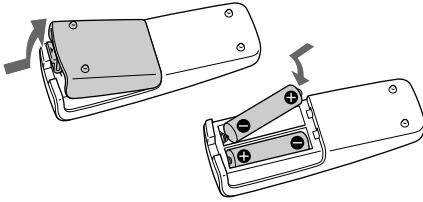

Notes

- With normal use, the batteries should last for about six months.
- Do not mix an old battery with a new one or mix different types of batteries.
- If you do not use the remote for a long period of time, remove the batteries to avoid damage from battery leakage and corrosion.

Setting the clock

- 1** Press I/⏻ (power) **[1]** to turn on the system.
- 2** Press CLOCK/TIMER SET **[21]**.
If the current mode appears on the display, press ◀◀/▶▶ **[10]** repeatedly to select “CLOCK SET” and then press ENTER **[16]**.
- 3** Press ◀◀/▶▶ **[10]** repeatedly to set the hour, and then press ENTER **[16]**.
- 4** Use the same procedure to set the minutes.

When you turn off the system after setting the clock, the clock display appears instead of the demonstration display.

The clock settings are lost when you disconnect the power cord or if a power failure occurs.

Basic Operations

Playing a CD/CD-G/MP3 disc

CD-G discs are supported only on the Mexican model.

1 Select the CD function.
Press CD **[3]**.

2 Place a disc.
Press **▲ [18]** on the unit, and place a disc with the label side up on the disc tray.

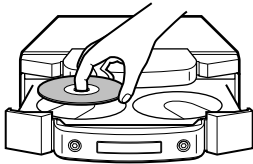

To insert additional discs, press DISC SKIP **[19]** to rotate the disc tray.

To close the disc tray, press **▲ [18]** on the unit again.

Do not force the disc tray closed with your finger, as this may damage the unit.

3 Start playback.

Press **▶** (or **▶||** on the unit) **[10]**.

4 Adjust the volume.

Press VOLUME +/- (or turn the VOLUME control on the unit) **[14]**.

Other operation

To	Press
Pause playback	 (or ▶ on the unit) [10] . To resume play, press the button again.
Stop playback	■ [10] .
Select a folder on an MP3 disc	📁 +/- [10] .
Select a track or file	⏮/▶▶ (or turn the MULTI JOG dial on the unit) [10] .
Find a point in a track or file (except for CD-G discs)	Hold down ⏮/▶▶ [10] during playback, and release the button at the desired point.
Select Repeat Play	REPEAT [22] repeatedly until "REP" or "REP1" appears.
Select a disc	DISC SKIP (or DISC 1 - 3 on the unit) [19] in stop mode.
Switch to CD function from other function	DISC 1 - 3 [19] on the unit (Automatic Source Selection).
Exchange other discs while playing	EX-CHANGE [19] on the unit.

To change the play mode

Press PLAY MODE **[26]** repeatedly while the player is stopped. You can select normal play ("ALL DISCS" for all discs or "1 DISC" for a disc or **📁*** for all MP3 files in the folder on the disc), shuffle play ("ALL DISCS SHUF" or "1 DISC SHUF" or **📁 SHUF***), or program play ("PGM").

* When playing a CD-DA disc, **📁** (SHUF) Play performs the same operation as 1 DISC (SHUF) Play.

Notes on Repeat Play

- All tracks or files on a disc are played repeatedly up to five times.
- You cannot select “REP” and “ALL DISCS SHUF” at the same time.
- “REP1” indicates that a single track or file is repeated until you stop it.

Notes on playing MP3 discs

- Do not save other types of files or unnecessary folders on a disc that has MP3 files.
- Folders that have no MP3 files are skipped.
- MP3 files are played back in the order that they are recorded onto the disc.
- The system can only play MP3 files that have a file extension of “.MP3”.
- If there are files on the disc that have the “.MP3” file extension, but that are not MP3 files, the unit may produce noise or may malfunction.
- The maximum number of:
 - folders is 150 (including the root folder).
 - MP3 files is 255.
 - MP3 files and folders that can be contained on a single disc is 300.
 - folder levels (the tree structure of files) is 8.
- Compatibility with all MP3 encoding/writing software, recording device, and recording media cannot be guaranteed. Incompatible MP3 discs may produce noise or interrupted audio or may not play at all.

Notes on playing multisession discs

- If the disc begins with a CD-DA (or MP3) session, it is recognized as a CD-DA (or MP3) disc, and playback continues until another session is encountered.
- A disc with a mixed CD format is recognized as a CD-DA (audio) disc.

Notes on the Mexican model

- You cannot select the graphic channels of CD-Gs or display CD-G images with fading effects.
- Some functions of the unit, when used during CD-G disc playback, may cause image distortion in the video output .

Listening to the radio

1 Select “FM” or “AM.”

Press TUNER/BAND **[3]** repeatedly.

2 Select the tuning mode.

Press TUNING MODE **[26]** repeatedly until “AUTO” appears.

3 Tune in the desired station.

Press +/- (or TUNING +/- on the unit) **[10]**. Scanning stops automatically when a station is tuned in, and then “TUNED” and “STEREO” (for stereo programs) appear. When you tune in a station that provides RDS services, the station name appears on the display (European model only).

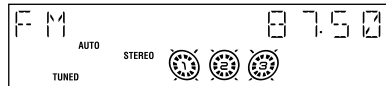

4 Adjust the volume.

Press VOLUME +/- (or turn the VOLUME control on the unit) **[14]**.

To stop automatic scanning

Press **[10]**.

To tune in a station with a weak signal

If “TUNED” does not appear and the scanning does not stop, press TUNING MODE **[26]** repeatedly until “AUTO” and “PRESET” disappear, and then press +/- (or TUNING +/- on the unit) **[10]** repeatedly to tune in the desired station.

To reduce static noise on a weak FM stereo station

Press FM MODE **[22]** repeatedly until “MONO” appears to turn off stereo reception.

Playing a tape

- 1** Select a tape deck.
 Press TAPE (or TAPE A/B on the unit) **[3]** repeatedly.
- 2** Insert a tape.
 Press PUSH **▲ [9]** on the unit, and insert the TYPE I (normal) tape into the cassette holder with the side you want to play facing forward. Make sure there is no slack in the tape to avoid damaging the tape or the tape deck. Press PUSH **▲ [9]** on the unit again to close the cassette holder.

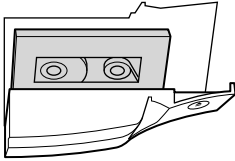

- 3** Start playback.
 Press **▶** (or **▶||** on the unit) **[10]**. Do not eject the tape during playback or recording, as this may cause irreparable damage to the tape and cassette holder.
- 4** Adjust the volume.
 Press VOLUME +/- (or turn the VOLUME control on the unit) **[14]**.

Other operation

To	Press
Pause playback	 (or ▶ on the unit) [10] . To resume play, press the button again.
Stop playback	■ [10] .
Rewind or fast forward	◀◀/▶▶ [10] .
Select Relay Play*	PLAY MODE [26] repeatedly until "RELAY" appears.

* After the playback of the front side of deck A, deck B plays the front side, and then stops.

Using optional audio components

- 1** Connect additional audio component to the AUDIO IN jack [12] on the unit using an audio analog cord (not supplied).
- 2** Turn down the volume.
Press VOLUME – (or turn the VOLUME control on the unit towards –) [14].
- 3** Select the AUDIO IN function.
Press AUDIO IN [3] on the unit.
- 4** Start playing the connected component.
- 5** Adjust the volume.
Press VOLUME +/- (or turn the VOLUME control on the unit) [14].

Adjusting the sound

To add a sound effect

To	Press
Reinforce the bass and create a more powerful sound	GROOVE [17] on the unit repeatedly until “GROOVE” appears.
Set the surround effect	SURROUND [17] on the unit repeatedly until “SURR” appears.
Select the preset sound effect	EQ [17] repeatedly. To cancel, press EQ [17] repeatedly until “EQ OFF” appears.

To turn on the subwoofer (MHC-GX470/RG590S/RG490S only)

Press SUBWOOFER [5] on the unit repeatedly until “SUB ON” appears. The SUBWOOFER indicator [4] on the unit lights up. If you later disconnect the subwoofer, repeat the procedure until “SUB OFF” appears. The volume of the subwoofer is linked to the front speakers.

Changing the display

To	Press
Change the illumination pattern around the VOLUME control [14] ¹⁾	ILLUMINATION [7] on the unit repeatedly.
Change information on the display ²⁾	DISPLAY [6] repeatedly when the system is turned on.
Change Display mode (See below.)	DISPLAY [6] repeatedly when the system is turned off.

¹⁾ Except for North American model

²⁾ For example, you can view CD/CD-G/MP3 disc information, such as the track or file number or folder name during normal play, or the total playing time while the player is stopped.

The system offers the following display modes.

Display mode	When the system is off ¹⁾ ,
Demonstration	The clock display is replaced by lighting and flashing of the display window.
Clock	The clock is displayed.
Power Saving Mode ²⁾	The display is turned off to conserve power. The timer and clock continue to operate.

¹⁾ The STANDBY indicator [2] on the unit lights up when the system is off.

²⁾ When the system is in Power Saving Mode, the following functions are unavailable:

- setting the clock.
- changing the AM tuning interval (except for European, Russian, and Saudi Arabian models).
- turning on the system by pressing the function buttons (for example, CD [3]).
- changing the CD power manage function.
- resetting the system to factory settings.

Notes on the display information

- The following are not displayed;
 - total playing time for a CD-DA disc depending on the play mode.
 - total playing time for an MP3 disc.
 - remaining playing time for an MP3 file.
- The following are not displayed correctly;
 - elapsed playing time of an MP3 file encoded using a VBR (variable bit rate).
 - folder and file names that do not follow either the ISO9660 Level 1, Level 2 or Joliet in the expansion format.
- The following are displayed;
 - ID3 tag information for MP3 files when ID3 version 1 and version 2 tags are used. (The Russian model can display information in Russian characters, but the characters may not be displayed correctly for discs created with some encoding/writing software and some recording device.)
 - up to 30 characters of ID3 tag information using uppercase letters (A to Z), numbers (0 to 9), and symbols (" \$ % ' () * , - . / < = > @ [\] _ ` { | } ! ? ^).

Other Operations

Creating your own CD program

(Program Play)

Use buttons on the remote to create your own program.

- 1 Press CD [3] to select the CD function.
- 2 Press PLAY MODE [26] repeatedly until “PGM” appears while the player is stopped.
- 3 Press DISC SKIP [19] repeatedly to select a disc.
- 4 Press [10] repeatedly until the desired track number appears.
When programming MP3 files, press [Folder] +/- [10] repeatedly to select the desired folder, and then select the desired file.

Disc tray number Selected track or file number

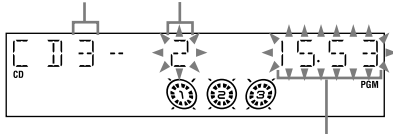

Total playing time of program
(including selected track or file)

- 5 Press ENTER [16] to add the track or file to the program.
“-- -- --” appears when the total program time exceeds 100 minutes for a CD, or when you select an MP3 file.

- 6 Repeat steps 3 through 5 to program additional tracks or files, up to a total of 25 tracks or files.

- 7 To play your program of tracks or files, press ► [10].

The program remains available until you open the disc tray. To play the same program again, press ► [10].

To cancel Program Play

Press PLAY MODE [26] repeatedly until “PGM” disappears while the player is stopped.

To delete the last track or file of the program

Press CLEAR [24] while the player is stopped.

To view the program information, such as total playing time and the number of tracks

Press DISPLAY [6] repeatedly while the player is stopped.

Presetting radio stations

You can preset your favorite radio stations and tune them in instantly by selecting the corresponding preset number. Use buttons on the remote to preset stations.

- 1 Tune in the desired station (see “Listening to the radio” (page 12)).
- 2 Press TUNER MEMORY **[25]**.

Preset number

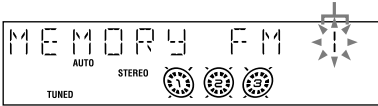

- 3 Press +/- **[10]** repeatedly to select your desired preset number.

If another station is already assigned to the selected preset number, the station is replaced by the new stations.

- 4 Press ENTER **[16]**.

- 5 Repeat steps 1 through 4 to store other stations.

You can preset up to 20 FM and 10 AM stations. The preset stations are retained for about half a day even if you disconnect the power cord or if a power failure occurs.

- 6 To call up a preset radio station, press TUNING MODE **[26]** repeatedly until “PRESET” appears, and then press +/- **[10]** repeatedly to select the desired preset number.

Recording onto a tape

(CD Synchro recording/Manual recording/Sound Mixing)

You can record on a TYPE I (normal) tape in three ways:

CD Synchro Recording:

You can record an entire CD onto a tape.

Manual Recording:

You can record just the portions you like from a sound source, including connected audio components.

Sound Mixing (Latin American model only):

You can “mix” sounds by playing one of the components and singing or speaking into a microphone (not supplied). The mixed sound can be recorded onto a tape.

Use buttons on the unit to control tape recording.

- 1 Load a recordable tape into deck B with the side you want to record facing forward, and then press TAPE A/B [3] repeatedly to select TAPE B.

- 2 Prepare the recording source.

For CD Synchro Recording:

Press CD [3] to select the CD function. Load the disc you want to record, and press DISC SKIP [19] repeatedly to select the disc.

When recording a folder from an MP3 disc, press PLAY MODE [26] on the remote repeatedly to select “ +/- [10] repeatedly to select the desired folder.

To record only your favorite CD tracks or MP3 files in your desired order, perform steps 2 to 6 of “Creating your own CD program” (page 16).

For Manual Recording and Sound Mixing:

Select the desired source to record or mix. To record only sound from a microphone, press CD [3], and do not start playing any other source in step 4.

- 3 Set deck B to stand by for recording.

For CD Synchro Recording:

Press CD SYNC [8].

For Manual Recording and Sound Mixing:

Press REC PAUSE/START [8].

4 Start recording.

While recording, you cannot listen to other sources.

For CD Synchro Recording:

Press REC PAUSE/START [8]. When the recording is completed, the CD player and the tape deck stop automatically.

For Manual Recording:

Press REC PAUSE/START [8], and then start playing the desired recording source. If there is noise while recording from the tuner, reposition the appropriate antenna to reduce the noise.

For Sound Mixing:

Press REC PAUSE/START [8], and then start playing the desired source and start singing or speaking into the microphone. If acoustic feedback (howling) occurs, reduce the volume, move the microphone away from the speakers, or change the direction of the microphone.

To stop recording

Press ■ [10].

Notes

- Recording stops if you change to a different function.
- You cannot eject the disc during CD Synchro Recording.

Creating your own sound effect

You can raise or lower the levels of specific frequency ranges, and then store the setting as “USER” in the memory.

- 1 Select the audio emphasis you want for your basic sound using EQ, and SURROUND and GROOVE on the unit [17].
- 2 Press EQ BAND [15] repeatedly to select a frequency band, and then turn the MULTI JOG dial [10] on the unit to adjust the frequency level. Repeat this for each band you want to adjust.

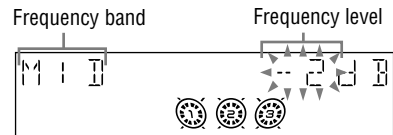

- 3 Hold down EQ [17] until “COMPLETE” appears. The setting is stored in the memory.
- 4 To call up the personal sound effect, press EQ [17] repeatedly until “USER” appears.

To cancel the sound effect

Press EQ [17] repeatedly until “EQ OFF” appears.

Enjoying karaoke

(Latin American model only)

You can sing along by connecting an optional microphone.

Use buttons on the unit for karaoke.

1 Turn MIC LEVEL [13] to MIN to turn down the microphone volume level.

2 Connect an optional microphone to the MIC jack [13].

The Mexican model has 2 microphone jacks.

3 For the Mexican model only:

Press KARAOKE [6] repeatedly to select “KARAOKE PON” for stereo-recorded CD, or “MPX L” or “MPX R” for multiplex CD.

4 Start playing the music.

5 Turn MIC LEVEL [13] to adjust the microphone volume.

If acoustic feedback (howling) occurs, reduce the volume, move the microphone away from the speakers, or change the direction of the microphone.

After you have finished, disconnect the microphone from the MIC jack [13].

For the Mexican model only:

To cancel karaoke mode, in addition to the above procedure, press KARAOKE [6] repeatedly until “” disappears.

To adjust the microphone reverb, turn ECHO LEVEL [13] to adjust the reverb effect. To cancel, turn ECHO LEVEL [13] to MIN.

To use CD-Gs, turn on your TV, and select the appropriate video input.

Note on the Mexican model

You cannot set the SURROUND effect when “KARAOKE PON” has been selected.

Using the Timers

The system offers three timer functions. You cannot activate both the Play Timer and the Rec Timer at the same time. If you use either with the Sleep Timer, the Sleep Timer has priority.

Sleep Timer:

You can fall asleep to music. This function works even if the clock is not set. Press SLEEP **[27]** repeatedly. If you select "AUTO," the system automatically turns off after the current disc or tape stops or in 100 minutes. Do not select "AUTO" during Synchro Recording of a tape.

Play Timer:

You can wake up to CD, tape or tuner at a preset time.

Rec Timer:

You can record a preset radio station at a specified time.

Use buttons on the remote to control the Play Timer and the Rec Timer. Make sure you have set the clock.

1 Prepare the sound source.

Play Timer

Prepare the sound source, and then press VOLUME +/- **[14]** to adjust the volume. To start from a specific CD track or MP3 file, create your own program (page 16).

Rec Timer

Tune in the preset radio station (page 17).

2 Press CLOCK/TIMER SET **[21]**.

3 Press **◀◀/▶▶** **[10]** repeatedly to select "PLAY SET" or "REC SET," and then press ENTER **[16]**. "ON" appears, and the hour indication flashes.

4 Set the time to start playing or recording.

Press **◀◀/▶▶** **[10]** repeatedly to set the hour, and then press ENTER **[16]**. The minute indication flashes. Use the procedure above to set the minutes.

5 Use the same procedure as in step 4 to set the time to stop playing or recording.

6 Select the sound source or prepare the tape.

Play Timer

Press **◀◀/▶▶** **[10]** repeatedly until the desired sound source appears, and then press ENTER **[16]**. The display shows the timer settings.

Rec Timer

Load a recordable tape into deck B. The display shows the timer settings.

7 Press **I/⏻** **[1]** to turn off the system. The system turns on 15 seconds before the preset time. If the system is on at the preset time, the Play Timer and the Rec Timer will not play or record.

To activate or check the timer again

Press CLOCK/TIMER SELECT [2], press **◀▶** [10] repeatedly until “PLAY SELECT” or “REC SELECT” appears, and then press ENTER [16].

To cancel the timer

Repeat the same procedure as above until “TIMER OFF” appears, and then press ENTER [16].

To change the setting

Start over from step 1.

Tips

- The Play Timer setting remains as long as the setting is not canceled manually.
- The volume is reduced to minimum during the Rec Timer.
- The Rec Timer is canceled automatically after the Rec Timer has been activated.

Troubleshooting

- 1 Make sure the power cord and speaker cords are correctly and firmly connected.
- 2 Find your problem in the checklist below, and take the indicated corrective action. If the issue persists, contact your nearest Sony dealer.

If the STANDBY indicator flashes

Immediately unplug the power cord, and check the following item.

- If your system has a voltage selector, is the voltage selector set to the correct voltage?
- Are the + and – speaker cords short-circuited?
- Are you using only the supplied speakers?
- Is anything blocking the ventilation holes on the back of the system?

After the STANDBY indicator [2] stops flashing, reconnect the power cord, and turn on the system. If the issue persists, contact your nearest Sony dealer.

General

The display starts flashing as soon as you plug in the power cord even though you have not turned on the system.

- Press DISPLAY [6] twice while the system is off. The demonstration disappears.

Sound comes from one channel, or the left and right volumes are unbalanced.

- Place the speakers as symmetrically as possible.
- Connect only the supplied speakers.

Sound lacks bass.

- Check that the striped (or solid) cord is connected to the speaker's – (or +) jack correctly.

Severe hum or noise.

- Move the system away from sources of noise.
- Connect the system to a different wall socket.
- Install a noise filter (available separately) to the power cord.

The remote does not function.

- Remove any obstacles between the remote and the remote sensor [20] on the unit, and position the unit away from fluorescent lights.
- Point the remote at the system's sensor.
- Move the remote closer to the system.

CD/MP3 player

The sound skips, or the disc will not play.

- Wipe the disc clean, and replace it.
- Move the system to a location away from vibration (for example, on top of a stable stand).
- Move the speakers away from the system, or place them on separate stands. At high volume, speaker vibration may cause the sound to skip.

Play does not start from the first track.

- Press PLAY MODE [26] repeatedly until both "PGM" and "SHUF" disappear to return to normal play.

Starting playback takes more time than usual.

- The following discs take a longer time to start playback.
 - a disc recorded with a complicated tree structure.
 - a disc recorded in multisession mode.
 - a disc that has not been finalized (a disc to which data can be added).
 - a disc that has many folders.

Tuner

Severe hum or noise, or stations cannot be received. ("TUNED" or "STEREO" flashes on the display.)

- Connect the antenna properly.
- Find a location and an orientation that provide good reception, and then set up the antenna again.
- Connect a commercially available external antenna.
- Turn off nearby electrical equipment.

Tape deck

The sound exhibits excessive wow or flutter or dropout.

- Clean the capstans and pinch rollers. Also, clean and demagnetize the tape heads. See “Precautions” for details (page 25).

To change the AM tuning interval

The AM tuning interval is factory-preset to 9 kHz (or 10 kHz, for some areas; this function is not available on the European, Russian and Saudi Arabian models). You cannot change the AM tuning interval in Power Saving Mode. Use buttons on the unit to change the AM tuning interval.

- 1 Tune in any AM station, and then turn off the system.
- 2 While holding down TUNING – **[10]**, press **I/⏻ [1]**.
All the AM preset stations are erased. To reset the interval to the factory preset, repeat the procedure.

To improve tuner reception

Turn off CD player power by using the CD power management function. By default, CD power is turned on. You cannot change the setting in Power Saving Mode. Use buttons on the unit to turn off CD player power.

- 1 Press CD **[3]** to select the CD function.
- 2 Press **I/⏻ [1]** to turn off the system.
- 3 After “STANDBY” stops flashing, press **I/⏻ [1]** while holding down **■ [10]**. “CD POWER OFF” appears. With CD player power turned off, disc access time is increased. To turn on CD player power, repeat the procedure until “CD POWER ON” appears.

To reset the system to factory settings

If the system still does not operate properly, reset the system to factory settings. You cannot reset the system to factory settings in Power Saving Mode. Use buttons on the unit to reset the system to its factory default settings.

- 1 Disconnect and reconnect the power cord, and then turn on the system.
- 2 Press **■, ▶|| [10]**, and DISC 1 **[19]** at the same time.
All user-configured settings, such as preset radio stations, timer, and the clock, are deleted.

Messages

- COMPLETE:** The preset operation ended normally.
- LOCKED:** The disc tray does not open. Contact your nearest Sony dealer.
- NO DISC:** There is no disc in the player, or you have loaded a disc that cannot be played.
- NO STEP:** All of the programmed tracks have been erased.
- NO TAB:** You cannot record because the overwrite protection tab has been removed from the cassette.
- NO TAPE:** There is no tape in the tape deck.
- NOT IN USE:** You pressed an invalid button.
- OVER:** You have reached the end of the disc while pressing ►► [10] during playback or pause.
- PUSH SELECT:** You tried to set the clock or timer during timer operation.
- PUSH STOP:** You pressed PLAY MODE [26] during playback.
- READING:** The system is reading information of the disc. Some buttons are not available.
- SET CLOCK:** You tried to select the timer when the clock is not set.
- SET TIMER:** You tried to select the timer when the Play Timer or Rec Timer is not set.
- STEP FULL:** You tried to program more than 26 tracks or files (steps).
- TIME NG:** The Play Timer or Rec Timer start and end times are set to the same time.

Display examples

Display	indicates
	2 (two)
	5 (five)
	6 (six)
	8 (eight)
	0 (zero)
	A
	B
	D
	G
	H
	K
	M
	O
	Q
	R
	S
	Z
	! or
∨	”
	\$
	%
,	,
.	.
	?
	@
^	^

Precautions

Discs that this system CAN play

- Audio CD
- CD-G (CD-Graphics) (Mexican model only)
- CD-R/CD-RW (audio data/MP3 files)

Discs that this system CANNOT play

- CD-ROM
- CD-R/CD-RW other than those recorded in music CD format or MP3 format conforming to ISO9660 Level 1/Level 2, Joliet or multisession
- CD-R/CD-RW recorded in multisession that have not ended by “closing the session”
- CD-R/CD-RW of poor recording quality, CD-R/CD-RW that have scratches or are dirty, or CD-R/CD-RW recorded with an incompatible recording device
- CD-R/CD-RW which is finalized incorrectly
- Discs containing files other than MPEG 1 Audio Layer-3 (MP3) files
- Discs of non-standard shape (for example, heart, square, star)
- Discs that have adhesive tape, paper, or sticker attached to them
- Rental or used discs with attached seals where the glue extends beyond the seal
- Discs that have labels printed using ink that feels tacky when touched

Notes on discs

- Before playing, wipe the disc with a cleaning cloth from the center out to the edge.
- Do not clean discs with solvents, such as benzine thinner, or commercially available cleaners or anti-static spray intended for vinyl LPs.
- Do not expose discs to direct sunlight or heat sources such as hot air ducts, nor leave it in a car parked in direct sunlight.

On safety

- The unit is not disconnected from the AC power source (mains) as long as it is connected to the wall socket, even if the unit itself has been turned off.
- Completely disconnect the power cord (mains lead) from the wall socket (mains) if it is not going to be used for an extended period of time. When unplugging the unit, always grip the plug. Never pull the cord itself.

- Should any solid object or liquid get into the system, unplug the system, and have it checked by qualified personnel before operating it again.
- The AC power cord can be changed only by a qualified service facility.

On placement

- Do not place the system in an inclined position or in locations that are extremely hot, cold, dusty, dirty, or humid or lacking adequate ventilation, or subject to vibration, direct sunlight or a bright light.
- Be careful when placing the unit or speakers on surfaces that have been specially treated (for example, with wax, oil, polish) as staining or discoloration of the surface may result.
- If the system is brought directly from a cold to a warm location or is placed in a very damp room, moisture may condense on the lens inside the CD player, and cause the system to malfunction. In this situation, remove the disc, and leave the system turned on for about an hour until the moisture evaporates.

On heat buildup

- Heat buildup on the unit during operation is normal and is not cause for alarm.
- Do not touch the cabinet if it has been used continuously at a high volume because the cabinet may have become hot.
- Do not obstruct the ventilation holes.

On the speaker system

This speaker system is not magnetically shielded, and the picture on nearby TV sets may become magnetically distorted. In this situation, turn off the TV, wait 15 to 30 minutes, and turn it back on. If there is no improvement, move the speakers far away from the TV.

IMPORTANT NOTICE

Caution: If you leave a still video image or on-screen display image displayed on your TV for an extended period of time via this system, you risk permanent damage to your TV screen. Projection TVs are especially susceptible to this.

Cleaning the cabinet

Clean this system with a soft cloth slightly moistened with a mild detergent solution. Do not use any type of abrasive pad, scouring powder, or solvent, such as thinner, benzine, or alcohol.

To prevent a tape from being accidentally recorded over

Break off the cassette's overwrite protection tab from side A or B as illustrated.

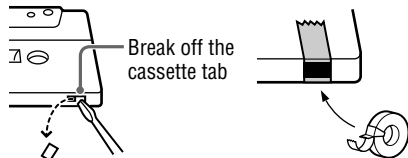

To later reuse the tape for recording, cover the broken tab with adhesive tape.

About a tape longer than 90 minutes

The use of the tape with more than 90 minutes of play time is not recommended except for long, continuous recording or playback.

Cleaning the tape heads

Use dry- or wet-type cleaning cassette (available separately) after every 10 hours of use, before you start an important recording, or after playing an old tape. Failure to clean the tape heads can cause degraded sound quality or an inability of the unit to record or play tapes. For details, refer to the instructions of the cleaning cassette.

Demagnetizing the tape heads

Use a demagnetizing cassette (available separately) after every 20 to 30 hours of use. Failure to demagnetize the tape heads can cause an increase in noise, a loss of high frequency sound, and an inability to completely erase tapes. For details, refer to the instructions of the demagnetizing cassette.

Specifications

Main unit

AUDIO POWER SPECIFICATIONS
POWER OUTPUT AND TOTAL HARMONIC DISTORTION:

(MHC-GX470 The United States model only)
With 6 ohm loads, both channels driven, from 120 – 10,000 Hz; rated 125 watts per channel minimum RMS power, with no more than 10% total harmonic distortion from 250 milliwatts to rated output.

Amplifier section

North American model:

MHC-GX470

Front speaker

Continuous RMS power output
(reference): 125 + 125 watts (6 ohms at 1 kHz, 10% THD)

Total harmonic distortion: less than 0.07%
(6 ohms at 1 kHz, 80 W)

Subwoofer

Continuous RMS power output
(reference): 150 watts (6 ohms at 80 Hz, 10% THD)

Total harmonic distortion: less than 0.07%
(6 ohms at 80 Hz, 90 W)

European and Russian models:

MHC-RG590S

Front speaker

DIN power output (rated): 110 + 110 watts
(6 ohms at 1 kHz, DIN)

Continuous RMS power output
(reference): 145 + 145 watts (6 ohms at 1 kHz, 10% THD)

Music power output (reference): 290 + 290 watts (6 ohms at 1 kHz, 10% THD)

Subwoofer

DIN power output (rated): 130 watts
(6 ohms at 80 Hz, DIN)

Continuous RMS power output
(reference): 170 watts (6 ohms at 80 Hz, 10% THD)

Music power output (reference): 340 watts
(6 ohms at 80 Hz, 10% THD)

MHC-RG490S

Front speaker

DIN power output (rated): 95 + 95 watts
(6 ohms at 1 kHz, DIN)

Continuous RMS power output
(reference): 125 + 125 watts (6 ohms at
1 kHz, 10% THD)

Music power output (reference): 250 +
250 watts (6 ohms at 1 kHz, 10% THD)

Subwoofer

DIN power output (rated): 120 watts
(6 ohms at 80 Hz, DIN)

Continuous RMS power output
(reference): 150 watts (6 ohms at 80 Hz,
10% THD)

Music power output (reference): 300 watts
(6 ohms at 80 Hz, 10% THD)

MHC-RG290

DIN power output (rated): 90 + 90 watts
(6 ohms at 1 kHz, DIN)

Continuous RMS power output
(reference): 120 + 120 watts (6 ohms at
1 kHz, 10% THD)

Music power output (reference): 240 +
240 watts (6 ohms at 1 kHz, 10% THD)

MHC-RG190

DIN power output (rated): 40 + 40 watts
(6 ohms at 1 kHz, DIN)

Continuous RMS power output
(reference): 50 + 50 watts (6 ohms at
1 kHz, 10% THD)

Music power output (reference): 100 +
100 watts (6 ohms at 1 kHz, 10% THD)

Other models:

MHC-RG490S

Front speaker

The following are measured at AC 120, 127, 220,
240 V 50/60 Hz

DIN power output (rated): 95 + 95 watts
(6 ohms at 1 kHz, DIN)

Continuous RMS power output
(reference): 125 + 125 watts (6 ohms at
1 kHz, 10% THD)

Subwoofer

DIN power output (rated): 120 watts
(6 ohms at 80 Hz, DIN)

Continuous RMS power output
(reference): 150 watts (6 ohms at 80 Hz,
10% THD)

MHC-RG290

The following are measured at AC 120, 127, 220,
240 V 50/60 Hz

DIN power output (rated): 95 + 95 watts
(6 ohms at 1 kHz, DIN)

Continuous RMS power output
(reference): 125 + 125 watts (6 ohms at
1 kHz, 10% THD)

MHC-RG190

The following are measured at AC 120, 127, 220,
240 V 50/60 Hz

DIN power output (rated): 50 + 50 watts
(6 ohms at 1 kHz, DIN)

Continuous RMS power output
(reference): 65 + 65 watts (6 ohms at
1 kHz, 10% THD)

Inputs:

AUDIO IN (stereo mini jack): voltage
250 mV, impedance 47 kilohms

MIC (phone jack) (Latin American
model only): sensitivity 1 mV, impedance
10 kilohms

Outputs:

PHONES (stereo mini jack): accepts
headphones of 8 ohms or more

VIDEO OUT (phono jack) (Mexican
model only): max. output level 1V_p-
p, unbalanced, Sync negative, load
impedance 75 ohms

SPEAKER: accepts impedance of 6 to
16 ohms

SUBWOOFER OUT (MHC-GX470/
RG590S/RG490S only): accepts
impedance of 6 to 16 ohms

CD player section

System: Compact disc and digital audio system

Laser Diode Properties

Emission duration: continuous

Laser Output*: Less than 44.6μW

*This output is the value measurement at a
distance of 200mm from the objective lens
surface on the Optical Pick-up Block with 7mm
aperture.

Frequency response: 20 Hz – 20 kHz

Signal-to-noise ratio: More than 90 dB

Dynamic range: More than 90 dB

Tape deck section

Recording system: 4-track 2-channel, stereo
Frequency response: 50 – 13,000 Hz (± 3 dB),
using Sony TYPE I cassettes
Wow and flutter: $\pm 0.15\%$ W. Peak (IEC), 0.1% W.
RMS (NAB), $\pm 0.2\%$ W. Peak (DIN)

Tuner section

FM stereo, FM/AM superheterodyne tuner

FM tuner section:

Tuning range

North American model:

87.5 – 108.0 MHz (100 kHz step)

Other models:

87.5 – 108.0 MHz (50 kHz step)

Antenna: FM lead antenna

Antenna terminals: 75 ohms unbalanced

Intermediate frequency: 10.7 MHz

AM tuner section:

Tuning range

Pan-American model:

530 – 1,710 kHz (with 10 kHz tuning interval)

531 – 1,710 kHz (with 9 kHz tuning interval)

European, Russian and Saudi Arabian models:

531 – 1,602 kHz (with 9 kHz tuning interval)

Other models:

530 – 1,710 kHz (with 10 kHz tuning interval)

531 – 1,602 kHz (with 9 kHz tuning interval)

Antenna: AM loop antenna, external antenna
terminal

Intermediate frequency: 450 kHz

Speaker

North American model:

MHC-GX470

Front speaker SS-RG490S for MHC-GX470

Speaker system: 3-way, 3-unit, bass-reflex
type

Speaker units: Subwoofer 13 cm, cone
type, Woofer 13 cm, cone type, Tweeter
5 cm, horn type

Nominal impedance: 6 ohms

Dimensions (w/h/d): Approx. 220 × 360 ×
235 mm

Mass: Approx. 3.8 kg net per speaker

Subwoofer SS-WG490S for MHC-GX470

Speaker system: Bass-reflex type

Speaker units: Woofer 20 cm, cone type

Nominal impedance: 6 ohms

Dimensions (w/h/d): Approx. 265 × 325 ×
325 mm

Mass: Approx. 5.8 kg

European and Russian models:

MHC-RG590S

Front speaker SS-RG590EU for MHC-RG590S

Speaker system: 3-way, 3-unit, bass-reflex
type

Speaker units: Subwoofer 13 cm, cone
type, Woofer 13 cm, cone type, Tweeter
5 cm, horn type

Nominal impedance: 6 ohms

Dimensions (w/h/d): Approx. 220 × 360 ×
235 mm

Mass: Approx. 3.8 kg net per speaker

Subwoofer SS-WG590SBG for MHC-RG590S

Speaker system: Dual cone type

Speaker units: Woofer 20 cm, cone type,
Passive radiator 25 cm

Nominal impedance: 6 ohms

Dimensions (w/h/d): Approx. 320 × 400 ×
330 mm

Mass: Approx. 7.2 kg

MHC-RG490S

Front speaker SS-RG490 for MHC-RG490S

Speaker system: 3-way, 3-unit, bass-reflex
type

Speaker units: Subwoofer 13 cm, cone
type, Woofer 13 cm, cone type, Tweeter
5 cm, horn type

Nominal impedance: 6 ohms

Dimensions (w/h/d): Approx. 220 × 360 ×
235 mm

Mass: Approx. 3.8 kg net per speaker

Subwoofer SS-WG490 for MHC-RG490S

Speaker system: Bass-reflex type

Speaker units: Woofer 20 cm, cone type

Nominal impedance: 6 ohms

Dimensions (w/h/d): Approx. 265 × 325 ×
325 mm

Mass: Approx. 5.8 kg

MHC-RG290

Front speaker SS-RG490 for MHC-RG290

Speaker system: 3-way, 3-unit, bass-reflex
type

Speaker units: Subwoofer 13 cm, cone
type, Woofer 13 cm, cone type, Tweeter
5 cm, horn type

Nominal impedance: 6 ohms

Dimensions (w/h/d): Approx. 220 × 360 ×
235 mm

Mass: Approx. 3.8 kg net per speaker

MHC-RG190

Front speaker SS-RG190 for MHC-RG190

Speaker system: 2-way, 2-unit, bass-reflex
type

Speaker units: Woofer 15 cm, cone type,
Tweeter 5 cm, horn type

Nominal impedance: 6 ohms

Dimensions (w/h/d): Approx. 200 × 325 ×
235 mm

Mass: Approx. 2.6 kg net per speaker

Other models:

MHC-RG490S

Front speaker SS-RG490AV/RG490S/RG490 for MHC-RG490S

Speaker system: 3-way, 3-unit, bass-reflex type

Speaker units: Subwoofer 13 cm, cone type, Woofer 13 cm, cone type, Tweeter 5 cm, horn type

Nominal impedance: 6 ohms

Dimensions (w/h/d): Approx. 220 × 360 × 235 mm

Mass: Approx. 3.8 kg net per speaker

Subwoofer SS-WG490S/WG490 for MHC-RG490S

Speaker system: Bass-reflex type

Speaker units: Woofer 20 cm, cone type

Nominal impedance: 6 ohms

Dimensions (w/h/d): Approx. 265 × 325 × 325 mm

Mass: Approx. 5.8 kg

MHC-RG290

Front speaker SS-RG490AV/RG490S/RG490 for MHC-RG290

Speaker system: 3-way, 3-unit, bass-reflex type

Speaker units: Subwoofer 13 cm, cone type, Woofer 13 cm, cone type, Tweeter 5 cm, horn type

Nominal impedance: 6 ohms

Dimensions (w/h/d): Approx. 220 × 360 × 235 mm

Mass: Approx. 3.8 kg net per speaker

MHC-RG190

Front speaker SS-RG190S/RG190 for MHC-RG190

Speaker system: 2-way, 2-unit, bass-reflex type

Speaker units: Woofer 15 cm, cone type, Tweeter 5 cm, horn type

Nominal impedance: 6 ohms

Dimensions (w/h/d): Approx. 200 × 325 × 235 mm

Mass: Approx. 2.6 kg net per speaker

General

Power requirements

North American model: AC 120 V, 60 Hz
European and Russian models: AC 230 V, 50/60 Hz

Australian model: AC 230 – 240 V, 50/60 Hz

Mexican model: AC 127 V, 60 Hz

Argentine model: AC 220 V, 50/60 Hz

Saudi Arabian model: AC 120 – 127, 220 or 230 – 240 V, 50/60 Hz, Adjustable with voltage selector

Other models: AC 120, 220 or 230 – 240 V, 50/60 Hz, Adjustable with voltage selector

Power consumption

USA model:

MHC-GX470: 240 watts

Canadian model:

MHC-GX470: 320 VA

European and Russian models:

MHC-RG590S: 205 watts

MHC-RG490S: 245 watts

MHC-RG290: 185 watts

MHC-RG190: 100 watts

Mexican model:

MHC-RG490S: 240 watts

MHC-RG290: 200 watts

Other models:

MHC-RG490S: 245 watts

MHC-RG290: 200 watts

MHC-RG190: 110 watts

Dimensions (w/h/d) (excl. speakers): Approx. 280 × 328 × 412.3 mm

Mass (excl. speakers)

North American model:

MHC-GX470: Approx. 9.4 kg

Canadian model:

MHC-GX470: Approx. 9.4 kg

European and Russian models:

MHC-RG590S: Approx. 9.5 kg

MHC-RG490S: Approx. 9.5 kg

MHC-RG290: Approx. 9.3 kg

MHC-RG190: Approx. 7.5 kg

Other models:

MHC-RG490S: Approx. 9.5 kg

MHC-RG290: Approx. 9.3 kg

MHC-RG190: Approx. 7.5 kg

Supplied accessories: Remote Commander (1), R6 (Size AA) batteries (2), AM loop antenna (1), FM lead antenna (1), Video cable (Mexican model only) (1), Speaker pads MHC-GX470/RG590S/RG490S (12), MHC-RG290/RG190 (8)

Design and specifications are subject to change without notice.



- Standby power consumption: 0.5 W
- Halogenated flame retardants are not used in the certain printed wiring boards.
- Lead-free solder is used for soldering certain parts.
- Halogenated flame retardants are not used in cabinets.
(Except for the United States model)

