

Mini Hi-Fi Component System

qOGA · °ULOKF

GameSync
M I X I N G

COMPACT
disc
DIGITAL AUDIO

*MHC-GX45/GX35/GX25
MHC-RG440S/RG330/RG310/
RG220*

dF b u ' qF& <'U bB 'L o d(' dD c
fiqK ' E' dDLK

<n B U UN'' W uN 'U WODG v - bLF <o
fi UN'' vK WKE ALC E <a - fidzU ' < dH
vK qz'u U W K 2 `UO ^ lC <'U bB ' E^ c
fi u e ' ' ' U q < UN'
E' V J ' ' E' q <oKG UJ w UN'' VO
fijzU(' w rLB ' E'

U "U t H p q Ø uB ØU UC ~ U~
fibOM Ø ' ~ u XMO U

t ^ vK nMB UN
v E_ ' W H ' s
CLASS 1 LASER
vK ' u u W UD
fiWOHK)' W



<W UF ' eM* ' 'U UH
fiw LULO 'U UHM W O W
NL

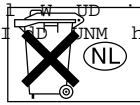

WO E_ ' E bK WBB< ' ' ~u* ' ' b
WOJ d ^ WENERGY STAR®
fiwk
Sony Corporation w u W d d energy
ENERGY STAR® w dAJ d UN HB
W dA W UF ' W UO ' l o ' u Z M* ' ' c ^
fiw UD ' WENERGY STAR®

'c vK UNO - UL 'sJ1 w UEM .

'U qO b 'c 'b

CD-ROM 'U 'uD -

b E 'b U qOGA 'UOKL W U• WHB qO qOGA 'UOKL fHM UOI 'sJ1 sJ <bF

doCD-R/CD-RW qO K WK U WLJ• 'U E^u^d^UL _' fH UN w 'E UN' 'bvK U 'u u*' 'WO U ' 'U ON ' Øb S WK fiWN UA 'UL ^

WO uB ' WLJ; ' W 'uD ' W O > fiqO b 'c w b • WO U

<† Øu *'fl- ISO9660 l WIMPS W O > 'bF *' q 'EomeL *Joliet

vMF** e d .

*Multi Session

'U 'uD - l UN 'b - sJ1 'WO u WLJ **CD**

fi'VK <l d qJ " U α w UOI '• qJA U XMP3 W 'u^d^b - sJ1 nzU **MP3** fi E E'UIBK UNOK •W 'uD -

fi'UIBK E^ U uKO E^ o j d • U UI UNOK W 'uD - MHC-GX45/ ' u**

'b CD-ROM 'U 'uD - vK 'bK : 'E 'UHKLK W QIRW W-2 MHC-RG220 GX35/RG440S/RG330/RG310 ISO fo UILK WO Eb ' W ON 'WD u b *' 'u** w 'WO Ed 'E WO E_ (International Standard Organization)

fiU d †- v - qB 'b* d sJ1

fiWO O{u ' u d .

Multi Session 'bF *' t; 'd*

'b U 'U UO W U{- UN D 'u sJ1 w ' qO UL WI d w sJ1 w ' 'U 'u^d^ Track-At-Once U(' w U *' WI d

oKD W 'uD U rJ% WIDM bM W bOKI ' WLJ; ' 'U 'u^d^ ' ^b UNO - qO ' UNOK oKD w Lnd-irbmu vM qO ' UNOK

Multi Session W ON U WLJ; Lead-out Ed fi

qO ' s r q U - l < 'bF q 'd ' - WLJ U M 'u^d^ c w vK WO U ' 'U 'u^d^ ' v fi 'dH WK dL Ed) ' qO ' v - u b ' fiUNO - UL ' sJ1 Ød _ ' 'U

WLJ W 'uD - 'U UO α 'uB CD-Extra W ON ' c " E b ' w ' 'U *' vK 'U UO 'E - E b ' w ' 'U vK 'WO u

fi†

'uB 'E U E^ vK 'U UO Mixed CD W ON ' c UNO - UL ' sJ1 w ' 'U 'u^d^

WO U ' 'U *' E w U ' U *' vK 'WO u WLJ W 'uD - 'U UO ' 'U u ; ' W 'u^d^ W W 'u^d^ W O

fi†

'u WO u WLJ 'U 'u^d^



'u COMPACT DIGITAL AUDIO Recordable COMPACT DIGITAL AUDIO ReWritable WLJ 'U 'u^d^ qO K WK U CD-R/CD-RW ' 'u 'U UO α

'u COMPACT DIGITAL AUDIO Recordable COMPACT DIGITAL AUDIO ReWritable WLJ 'U 'u^d^ qO K WK U CD-R/CD-RW *MP3 'UHK α



MHC-GX45/GX35/RG440S/RG330/RG310 ' u** jI 'WO Wd E E_ ' u MHC-RG220 E

W UL 'UOMI dHA** WOIO u** WK ULd' WLJ; 'U 'uD ' uB
 l D ' uI **CD-RW** qO ' **CD-R** qO K
 l o UD w 'U 'uD ' v - UL qO LB K UN' UI 'c WLJ; 'U 'uD ' qOGA
 iF X d b (CD) WLJ; 'W 'uD ' fo UI d sJ fiU 'b S **CD-R/CD-RW** w '
 WHK WOIO u 'U 'uD ' 'u _ w fO p -L 'U d'ud ' iF v - UL ' sJ1
 b u t ^ WE v d fil D ' uI W UL 'UOMI 'ud dHA W U L^ qO ' w b
 fo UI l o UD <'U 'uD ' c 5 'U 'uD ' iF ' GA .vK WK * 'U 'ud
 fi UN' 'c vK UNO - UL ' r ^ sJ1 q WLJ; 'W 'ud ^ < Lb 'u L V UNO -
 fiqGA** hzUB L^ qO '
 vK WK W 'uD - v - UL ' r b **CD-R/CD-RW** 'U 'uD ' v - UL ' sJ1
 ~bF q 'd UL U 'L w ' WOKLF 'a WOZUNM '
 fi'G'UF ' W 'ud ' qGA s W
 UNOK EdF **CD-DA** WK < d*U W 'ud ' . ^ b ~bF q 'd **CD-RW** **CD-R** 'U 'ud ' .
 u F ' r v UL **CD-DA** WE 'u Du Sa fiUNKOL% r b q 'd** - " w
 fiMP3 WK d vK
 W 'ud S UNOK MP3 WK d*U W 'ud ' . ^ b UN b_u MP3 W'ON 'UHK qOGA s . UEM '
 CD-DA WK d vK u F ' r v MP3 UL ' dL L fiMP3 q ~'b -
 fi'u a ~'b MP3 W ON U X O 'UHK v ' UL
 dH *' VO d MP3 W 'ud UL ' Ø b b b% r w qK L^ 'U { ,Lb v ~ MP3 ^ sJ1
 fiW 'ud ' qOK% s "UM ' nKLK finzU u '
 W 'ud S UNOK EdF ' r WDK W 'ud - ISO 9660 dO Ød ^ W .ON w ' 'UHK** L^ *
 fi'u **CD-DA** - W .ON - W 'ud - W 'ud dF ^ sJ1 <† Øu *' L^ *
 fi u Ø L UNO - UL ' `b dG WO
 fibIF dH VO d WK W '
 fi ~bF q 'd vK WK W 'u
 UN u w l {u r W 'ud -a UNO -> 'U UO W
 fi'WOZUNM '

UEM VO d

fiWI d** 'UO ULJ 'E a _' 'b **5**U v **1**bWO UEM**'VOKHF ' US

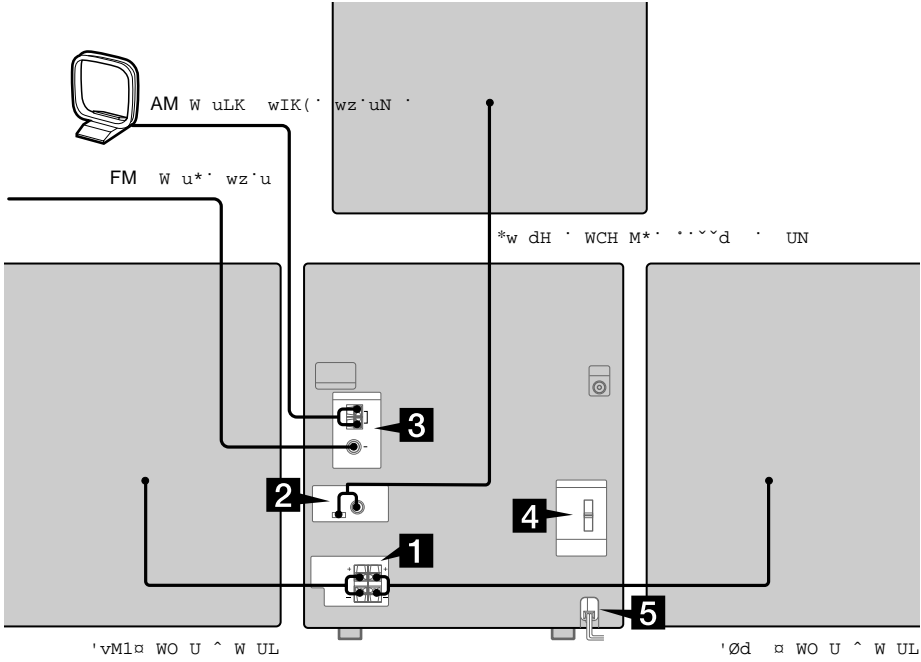

jI MHC-RG440S MHC-GX45 ' 'u**'

fiw dH ' WCH M** ' 'vvd ' **2** qO u r

'jI **MHC-RG440S** **MHC-GX45** ' 'u**'Ø

f I v - W UL ' a ^ qO u r fi U ^ ^ \{u **SPEAKER** qO u ' a ^

f I **SUB WOOFER OUT**

fi U ^ ^ \{u **SUB WOOFER CONTROL**

jI ØuAJ* ' 'e' q ^ ^

SUB WOOFER OUT f I

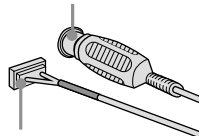

SUB WOOFER CONTROL f I

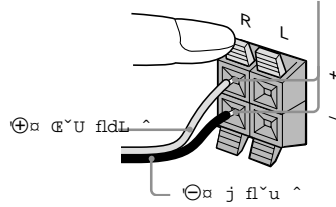

fi 'b'' w 'u u*' UO ' c Q v **5** UO ' pK qO f**FM/AM** 'U u*' 'UOz'u **3** u r
 e ' jG{ bM fi dF ' W U vK w UC ' l{fitKODNE AM W uLk wIK(' wz'uN ' j
 l{u ' wN M E qOGA ' l{E/⊕- UEM ' u <
 fBOzUIK w UC
 qB - < 'b'' w 'u u*' f I*' l f U
 T UNO eN:' ' 'u*' q ^ s a o d*' f U l' T UN



AM W uLk wIK(' wz'uN ' .

b E w **AA** r **R6** 5 UD U
 bF s rJ

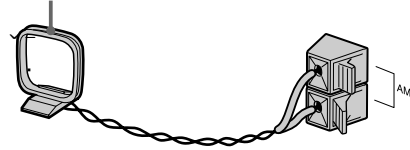
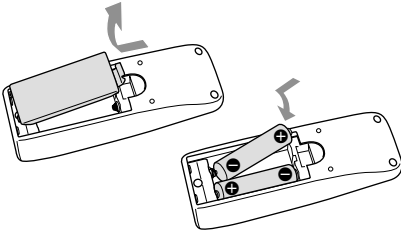

FM W u*' wz'u pK b bL r

WE

fiW UL ' a°bOFs wz'uN ' kH

UD ' e - <WK u WOM d H bF s rJ
 fi P W E UD ' qzU ' d s qL ; hK WOD u H
 WE j { - <WOD u H : UO - ' U H O eN **4** ' u L
 WE WOD u H
VOLTAGE SELECTOR U H*
 fiWOK ; ' UO ' .
 boh 'U -
 U bM fiI uN ' W UD ' dL uJ <E'UF ' JLE ' U H* vK ' u u*' W u D*
 5 UD ' b - < UN' qOGA s bF s rJ C . WOKL **VOLTAGE SELECTOR**
 b E sUL
 fi5 b b 5 d Q
 fiW UM* .

W UL ' 'UOA j

'U UL ' qH ^ vK WI d* WO U _ W UL ' 'UOA
 fiUN e - E'UH E UN O

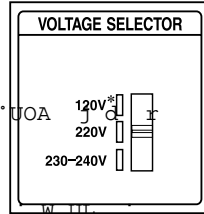

E MHC-GX45/GX25/RG440S/RG310
 MHC-RG220

X u -t• ->t "W 'uF ' WO dF ' *WJkLLK hE

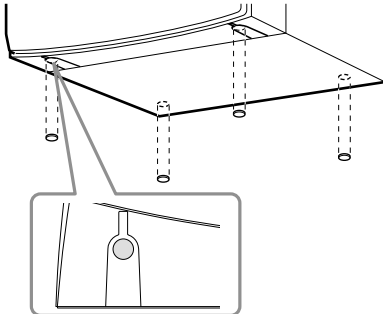

UL
v
U
WLJ
u

W 'uE - v -

MP3flWO u WLJ 'U 'uE - v
W 'uD - qOL%

wz'uAF ' UL 'flE'UF ' UL

MP3 CD

WO u WLJ 'U 'uD - v - UL ' p 'O UEM . fi UN'' ▲K e ' jG{-
fiMP3 WO u ' ' U 0 'U 'uE 'Et u ' qF l 'U 'uD ' WOMO 2 vK W
'u*' MP3 WO u ' ' U v - UL ' sJ1 fivK _ W UD ' qL
'u*' MHC-RG220 MHC-GX25

fi'WO ENO' E E_

W 'uD - qOL% bM " U

W 'uD ' WOMO E * r



W 'uD ' 5 UL ' X E

iCD e ' jG{-

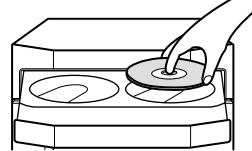

e ' jG{- <WO U{- 'U 'uD -
d Lb UDISC SKIP/EX-CHANGE
fi'U 'uD ' WOMO
WOMO oKG ød ^ d ▲ UN'' jG{-
fi'U 'uD ' 3

'UE
'c _ WI 'u E^ jz'd <'UIBK •UNOK W
fiWHO u'K wV ^ sJ1
sJ1 'c _ <pF Q UN 'U 'uD ' •WOMO v
fiWHO u'K wV ^

1

```

Ød _' qOGA ' 'UOKL uB ÆUI ' lPLAY MODE e ' jG{-
-----
WO U ' WOKLF ' U$S rq ^ s      fi dF ' W U vK t d Ec ' l{u ' dNE v
-----
f e ' jG{- UL ' ÆUI          v - UL          d -
-----
Ød ^ d tG{ē fi jG{- X R*' nO u . WOMO w 'u u*' 'U 'u ALL'DISCS
fi UL ' ÆUM                      fi dL          uB 'U ' @DUF'' UL ' α
-----
uB▶▶ e ◀◀^ e ' jG{ ' U UO - w ' W 'uD ' vK 'u u*' 'DISC*'
fi dJ                          fiwK _' VO d U UN'AF'' UL ' α
-----
uB+ ALBUM- e ' jG{*MP3 u ^ UO - u _ MB3 WO uB ' ' U *' lALBM
f2 uD)' bF dJ                  UN d ' w ' W 'uD ' @DUF 'u uL' ' α
-----
`UN▶▶ e ◀◀ e ' jGC kH - w WDI ~U - MP3 X O W 'uD - v - UL ' bM
fiW u d*' WDIM ' bM d L UL* U'  UL ' v - u UL ' u
-----
e ' LSKIP e ' jG{L w W 'uD ' UO - fi DISC b 'L W 'uD
e '**DISC1-3 ÆUI ' 'U 'uD ' lOL vK 'u u*' ALL'DISCS'
vK DISC SKIP/EX-CHANGE          fiwz'uA VO d SHUF
fi UN''                          'wz'uAF'' UL ' α
-----
vK DISC 1-3 ' _' b ^ G{ ' WHO L v - q u w' ' W 'uD ' vK 'u u*' DISC SHUF*'
fi OzUIK bb*' UO -cd UN' 'bB s      fiwz'uA VO d 'wz'uAF'' UL ' α
-----
e ' jGØd ^ 'U 'uD - 'b ~u u*' u MP3 WO uB ' ' U *' ALBM
vK DISC SKIP/EX-CHANGE UL ' `UM ^ VO d UN d ' w ' W 'uB SHUF vK
fi UN''                          fiwz'uA 'wz'uAF'' UL ' α
-----
fi UN'' ▶K e ' jG{ ' W 'uD ' d . MP3 X O W 'uD - v - UL ' bM
v - u wz'uAF'' UL ' u
-----
dF ^ sJL b fi DISC SHUF
fi 'UHK*' iF W O uB X-u'
MP3 WO uB ' ' U *' `UM VO d W 'uD ' vK 'u u*' PGM *'
UO BM uJ s DISC 1-3 vK e *' Z U d ' qL l ' α 'u 'd *UL UL' ' α
fi ALL DISC SHUF
fi -† W H w p b qCH*'

```

MHC-GX45/GX35/RG440S/RG330/RG310 ' ~u**
 jI 'WO Wd EEE' ~uMHC-RG220 L

UL
v
uE
v
WLJ
u
MP3

dJ * UL

UL -dJ

MP3 CD

vK b 'E U E^ ' U *' LOL v
fiW 'uD
v u *' MR3 WO uB ' ' U *' v -
v u *' MHC-RG220 MHC-GX25
fi'WO E d ' E E_

dF ' c U ' b

fi REP1ç E REPç dNE REPEAT e ' jG{-
v W 'uD ' vK v u u *' * REP *'
fi ' d
fijI b 'E U REP1^ s "

UL ' dJ `UG

s wH v REPEAT uB ' jG{-
fi REP1ç E REPç

'UE

fH wAL DISCS SHUFç E REPç UO - pMJ1 s
fiX u '
r v W UN U v - REP1ç ' c UO ' dJ bM r <ç
fi REP1ç `UG -

'UE
fi UL ' `UM ^ qOGA ' i {E dOO
WK *' 'U 'uD ' v - UL ' ' b * u ' iE
fi v bF *' 'UI D ' q bIF
fiW 'uD ' ' U LOL ' dI qGA *' uI <W
vK MP3 X O WO u ' U E^ dO ' U u
UL ' ' b E^ ° U E E d b ' dG b <W ' u
fiw IMP3 w uB ' U LK
v u *' pMJ1 - W Ed { dO ' ' U E^
bF w u MP3 fi - UL W b MP3 ' uD '
vK W E d { DOG ' ' U u ' E^ ' U *' s q
SUJ fMP3 WO u ' ' U UN W ' u
fMP3 w u U sLC Ec ' ' u ' w
'w U ' bK : ' WK U u ^ - " ' U u ' v
^ sJ1 MP3 WO uB ' ' U u ' E ' ' U *' v bF
fi# u b 'E W ' uD - UN
vK UNKO MP3 WO u ' ' U v - UL
fiw 'uD
UDJ - < UL " ' s sJL ' b q q UA *' i
LOL q UN <W U J U dO H - E `Z {UC d ' E ' uB
fMP3 w uB ' U *' qO bM b *' qO

fiWO U{ 'U 'uD ' E^ 6 U
 'u d) ' d W d q ^ s
 5 B Ød ^ 'U 'uD -
 5 H W 'uD ' fH vK Ød ^ 'U
 5v 3 Ød ^ 'U 'uD ' vK Ød ^ 'U

W d p b qCH* ' Z U d

Z d * ' UH

MP3 CD

f▶ e ' j7{-

fIZ d * ' UL ' ^ b j d vK W d * ' ' U LK s ' e qO
 Ød _ ' qOGA ' 'UOKL

'U 'uD ' LOL s uD † v - qB Z U d
 fi"u d* ' qOGA ' VO d
 fi' - • W H α XO U
 'u* ' MR3 WO uB ' ' U * ' v - UL
 'u* ' UMHC-RG20 MHC-GX25
 'UG - fi'WO EMO E E_

WO U ' WOKLF ' USS r q ^ s
 uPLAY MODE e ' jG{ U d v - UL
 wH v EUH ' l{E w dJ
 fiPGM

fiEUI ' l(CLEAR e ' jG{ ' W UN s U 'UG :
 Z U d

dF ' c U ' b

fCD e ' j1{-

UL fIZ d * ' UL ' \UN - bF *TKLF l{E w dJ
 f▶ e ' jG{ CD re < jG{- <Ød ^ d Z U d ' fH v -
 fi'U 'uD ' WOMO ' bm Z U d 'UG
 E^ <WIO ^ - W 'uD ' Z U d - s dNE U bm E^ U UN
 U UO - bm E^ <vK ^ E^ † - r 'U 'uD ' UO
 fMP3 w u

PLAY MODE e ' j2{-
PGM dNE v EUI

DISC 1-3 e ' j3{-
DISC SKIP/EX-CHANGE

v - bI < U(' w W 'uD ' vK ' ' U *
 fiALç d I uD)

r dNE v dJ ▶▶ H◀◀ jG{ 4
 fi"u d* ' U *

UO + ALBUM - e ' jMP3 W d bm
 v dJ ▶▶ H◀◀ jG{- r < u _
 fi"u d* ' U * ' r dNE

'U 'uD ' WOMO U * ' U * ' r

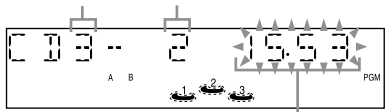

wKJ ' UL ' X E
 ' U < ' U * ' WK U α

fENTER e ' j5{-

fi U * ' W d r
 fiwKJ ' UL ' X E UNF <Z U d ' u

TUNER MEMORY e · j 3

fio * · j C · r d

o * · j C · r



vK >>> <<< e PRESET -/+ e · j 4

o * · j C · r UO dJ

fi"u d*

fENTER e · j 5

fiØd ^ · UD 5 (v 1 · · uD) · 6

U Eb WH · uLK o

· UD LK u · d · U · Eh WH Lu*U

fiW u d*

UO dJ TUNER/BAND e · j 1

fiAM ç E FM ç W u*

>>> <<< e TUNING -/+ e · j 2

fiW u d* · WD; · WH · u* dJ uB

TUNER MEMORY e · j 3

fio * · j C · r

vK >>> <<< e PRESET -/+ e · j 4

o * · j C · r UO dJ

fi"u d*

fENTER e · j 5

fiØd ^ · UD 5 (v 1 · · uD) · 6



W uLK · UD FM W uLK WD † KH pM
W uN · UD; · pK s WD E^ AM · u cz
fio UD* · o * · j C · r UO

uB · UN

U OzUIK WH · uLK o *

w UN U I · sJl w · · UD; · lol WH
fiW u d* · · UD LK u · U OzUIK · dp EDM

UO dJ TUNER/BAND e · j 1

fiAM ç E FM ç W u*

* E · j C TUNING -/+ e · vK jGC U KH -
r <DOG · w · d · UO >>> v · U

UOI · pMJl fitM pF · l ·

fiW u d*

n u fi · UD; · · WOKLF UEM · uI U

<X u · c w fiWD U OzUIK rY U · WOKL

Z U d STEREO ç ETUNED ç U U F · dNE

fi'u dFM



dNE

çTUNED ç dNE r E Y · WOKL XH u

uB · WUN · {u u UL W u d* · u · d · WD

°U Eb WH · uLK o6 v 2 j (uD) · s

fi'- † W H □

1

u ~ d ~ v -

UL . Ød _ qOGA ' 'UOKL

w W uH WD UO U U - u ~ d ~ WD * v j c . UL w W {u* ' 'UU- ' -LWD- WH 'u
fE Lb WD; ' WH 'u0 E ^ d fi '- ‡ W HØcEb' WH 'uLK WHOF{

jG{ -3 < uD) ' lbE fi uD) ' s ^ b - Ød ^ WD j {
▶▶ H ◀◀ E PRESET -/+ e ' uH o j {

d 'c ' w W uH WD v - rUL UO . dJ uB ' UN ' ' vK

d 'c ' w W uH; ' °UD; ' WH 'u fitO

kH dE ^ n 'u* ' d ' - w u ~ d ~ ' °UD kH r . UAM W uLK WH 'u* ' U - dO
fi '- ‡ W H w d 'c ' w WBB < d : ' u* ' U

UO dJ **TUNER/BAND** e ' j1 { -
fi AM c E FM c W u* '

vK lmb * UI w AM W uLK WH 'u* ' U - j
U - dOOG fi 'o UM* ' iF w e d uKO

vK ▶▶ H ◀◀ e **PRESET -/+** e ' j2 { -
W uH; ' W u d* ' WD; ' UO dJ uB , UN e ' vK jGC U UH : ' UM ^ fi UEM

r ° E AM W uLK WD E ^ AM W uLK r WH 'u* ' U -
uB , UN e ' vK jGC U UH : ' UM ^ fi UEM

o * j c ' r ~ d ~

I/O e ' jG{ - < UN ' **TUNER/BAND** ' UD LOL u r < WH 'u* ' U - dOOG
r < U ' j { ~ U fi AM w u* w W uH
fiWOKLF ' FH ' dJ

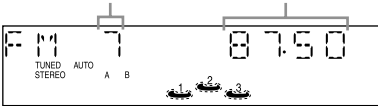

WE

fi bI ' kH AM W uLK WH 'u* ' U - dOOG

boh ' ' U -

qBH XL ' E dI u b* d 'c ' w W uH; ' ' U
fi UO K UDI - , b E ^ UO ' ' U

wz 'u qO u r E ^ WI d* ' 'UOz ' uN ' j { - <
fiw U

u ˇ'd ˇ' °U UO
(RDS)

UE w UHF dOG ˇ' u ˇ'd ˇ' °UD v
d ˇ' c ˇ'

W Lbo ˇ'-WH ˇ'u ˇ'

'jI WO E E_ ˇ' EbK hB< ˇ' q ˇ'u ˇ' ˇ'

UO dJ TUNER/BAND e ˇ' j d {
fi AM e L FM e W u ˇ'

ˇ'u ˇ'd ˇ' °U UO UE >> u U << e TUNING -/+ e ˇ' j e {

'UD; ˇ'L w ˇ' Y (RDS) bu ˇ'd ˇ' °U UO fi u d * ˇ' WD; ˇ' WH ˇ'u ˇ' dJ uB ˇ' U

UE fiW ˇ'UF ˇ' Z U d ˇ' U - l WO U { ˇ' U uKf U S u ˇ'd ˇ' boh ˇ' ˇ' u -
*fi j IFM ˇ' U uLK ˇ' U u ˇ'd w z ˇ' U u r E ^ < WI d * ˇ' UOz ˇ' uN ˇ' j {
fi ˇ' u ˇ' w ˇ' U w U

WE e ˇ' j { - < WOJO U u FM U { ACU d ˇ' uJ U bM
w ˇ' WD; ˇ' q d r ˇ' - W O uB u ˇ'd d NE ˇ' U uO UE STEREO/MONO HFM MODE
X U ˇ' - E ^ W O uB u ˇ'd ˇ' °U UO UES U S J U N d u O Q MONO e u F s ˇ' fi e
fiWHOF { U ˇ' fi U I ˇ'

vK >> + E << e TUNING -/+ e ˇ' j GC ˇ' kH -
d u E u ˇ'd ˇ' °U EM WUE ˇ' UUD l bL d wD WH ˇ'u0 UEM ˇ' uI U bM ˇ' * ˇ' n u E ˇ'
ˇ' U UO UEM WO U W ˇ' vK sJ r ˇ' - fi ˇ' U b) ˇ' s uM ˇ' fH fi 'WOz U I K ˇ' WH ˇ' u
s b e vK uB K WOK; ˇ' u ˇ'd ˇ' °UD 0 q ˇ' - q H ˇ' d E Lbo ˇ' qO ˇ' b ˇ' < u ˇ'd
fi p IDM w u ˇ'd ˇ' °U UO UE ˇ' U b s ˇ' U uKf *

ˇ'UM MHC=RG220 MHC-GX25 ˇ' u ˇ' q ˇ' ^ s

RDS u ˇ'd ˇ' °U UO UEM Y Z ˇ'd U I - 'WO Lbo E E_ ˇ'u ˇ'

fM W u ˇ' s WD UO - - pOK U
dNE < u ˇ'd ˇ' °U UO UE ˇ' U b bI WD WH ˇ'u0 uI U bM
fi dF ˇ' W U vK WD; ˇ' r -

RDS u ˇ'd ˇ' °U UO UE ˇ' U uKf s oI K
uB dF ˇ' DISPLAY < e ˇ' UNO jGC d q
"wK UL W E ˇ'

d ← * Z U d ← WD; ˇ' < ˇ' WD; ˇ' r -
d R * ˇ' W U ˇ'

r - S < W O uB u ˇ'd ˇ' °U UO UE Y U I - r r ˇ' -
fi dF ˇ' W U vK dNE b WD; ˇ'

j d v - UL

j d v - UL

fi'G~UTYPEI uM ' s j d ULF

j d qOL%

fij d qOL 1 r

e ' jG{- <WK 'u uB s UN'
dNE v dJPLAY MODE

UN' UL

dTAPE A/B e ' jd{-
fB IA

fi dF ' W U*'qK'u *' URELAYç

fi UN' RUSH ▲ e ' j2{-

f▶ e ' j2{-

fij dA ' v - UL

'wb tOK qO ' sJl j d flq j 3 qOL
ftO - UL ' 'd* B WA UN' l

fi U UN tOK qO



B UN' AuIUN<K w U _ ' V U' *v - UL ' bF
fin u r w U _ ' V U' qOGA

'd* v U' qF
tOK qO 'ftO -
fi U UN

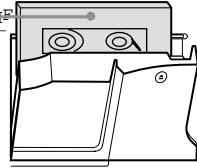

Ød _ ' qOGA ' 'UOKL

WO U ' WOKLF ' USS rq ^ s

f■ e ' jG{- UL ' ÆUI -

Ød ^ d tIG{ē fi jG{- X R*' nO u '
fi UL ' ÆUM

f▶▶ E◀◀ e ' jG{O d ' E^ l d ' .bI ' .

fi UN' RUSH ▲ e ' jG{- j d ' d -

*(AMS) w U ' E^ w U(' U *' W 'b s Y ' .

.bI K

fi UL ▶▶▶IM ē ' jG{-

fiçTAPE B E TAPE A >>>+lç U F ' dNE

lo d K

fi UL ◀◀◀IM ē ' jG{-

fiçTAPE B E TAPE A <<<-lç U F ' dNE

'wzUIK ' vIO AMS dFA □

WE

X% W O uB wzUIK ' vIO u*' dFA WHO E qLF b
"WO U ' ÆLdE "

fi 'u . s q ^ w U _ ' 5 WK *' dO W U *' u uJ U BM
fi u eHK ' s "dI U- UN' l{E BM

U Lb j d vK qO

j d vK qO

ELbo · qO-

p b WKCH* · · U * ·

E^ j d <W 'uD - s jI U b d w · · e _ qO PMJ1 j d vK
fij d vK u · d Z 'd

eN ^ qO u dE -α WKB UC ENpMJ1 qO · j d v - W 'uD qOs - e · e *
fi't W H w W UO -

fB UN'· w tOK qO · sJ1 j d qOL r fij d vK WK U W 'uD - qO
j { r fiTYPE b um · s j d ULF -

TUNER/BAND TAPE A/B CD e · j2{-
"u d*· bb*· (GAME) GAME (MD) fiBOZUIK qO · ØU

fitKO fB UN'· w tOK qO · sJ1 j d qOL

fi UEM · · cN WLJ;· W 'uD · qGA· s qO fiUNKO "W 'uD w · W 'uicD · qOL j2{- E

fi UEM A · cN · s qO * " j d fi UN'· **CD SYNC** e · j3{-

fi UEM · · c n 'u s qO K "u · diqO K · 'bF B lU/v - u

v - q u u bo "UF ^ UN sUNqO K ""UF ^ fiRECç i u

fGAME INPUT AUDIO L/R f UI

fi UN'· **REC PAUSE/START** e · j4{-

MHC-RG220 MHC-GX25 · · u*· q* ^ s fiqO · ^b
'WO EdO'EL E' · u*· `UM U α

fi UN'· **REC PAUSE/START** e · j3{- fiqO · #UI

fiqO K · 'bF B lU/v - u f e · jG{-

fiRECç i u

· · U * · VO d b b W 'uD -

r < UN'· **REC PAUSE/START** e · j4{- · b U jI p b WKCH*· W 'uD · · ·

fitKO · u Cc · bb*· v - UL 2 : : qD) - · · d3S2 f uD) · 5 fiZ d * · UL

fiqO · ^b fi'-t W H α p b qCH*· W v d · c

qO · #UI

f e · jG{-

WE

fiqO · · `UM ^ Ød / `UB v - UL · s sJL s

boH `U -

"u · d · s qO · uB

wz'uN · · ad <u · d · s qO · `UM ^ `U{u{ · u Lb bm

fi`U{uc · iOH U)

l u bOH · "UF ^ °u jKW U · °u d R UO
Ød _ · °uB · ^UB

"UF _ jK

fSURROUND e · jG{-

fi dF · W U SURROUNDNE

fSURROUND `UG Ød ^ d e · fH

fi"u d*· `uB · bB 1 d -

fi UN"· **GAME MIXING** e · jG{-

u bOH · "UF ^ °u

"UF _ · °u Øu dOG < e · UNO jGC d q

"wK UL W E^ uB

W FK '-s 'e

← MIXING MID ← MIXING LOW
MIXING OFF ← MIXING HIGH

w W UO - eN ^ qO u dE -a u bo
fi't W H

WE

f*GAME fGAME (MD) e · jG{-

jK `UG - r <"UF _ jK WHO E JOAM `UM ^ qO
GAME MIXING e · jG{- <jK < `uB · qO · fi"UF ·

W H wE Eb j d vK qO uD)" bB UN"· vK UM MHC-RG220 MHC-GX25 · `u*· q* ^ s
`b UNREC/PAUSE/START e · jG{- r <-· 'WO EWO'EL E' `u*·

fiqO

boh · ·u -

boh · ·u - fiqOGA · lqzWIK UEM · u · <· `bF

fi"UF _ jK **GAME MIXING** d R*· TC fiOz GAME EQ W FK · 'u· UO

bI · uJ U bM WDA qE UN S <"UF _ jK WHO E JOAM d lE w c qOGA J1 'S'UOKL
fi`uB · bB dOOG bM v qOGA · l{E w

.uB · j }

vIO u* · UG ^ vK

X R*

w u X-R

vIO u* · UG ^ vK

fBI u C* · X u · bM vIO u* · UG ^ vK UIO · pMJ1
fi', W H w W U · j { dE -a W U · j { s b Q uM · X-R

fitO - UL · u de · wIO u* 1 bB* · dQC · pMJ1 YO <5F X E bF n u O UEM
U s UL · b fiw 'u d · qOL r "W 'u d - fivIO u* · UG ^ vK
qCH* · Z U d · qL dE -a Z U d qLF r <b

fi'-† W H w p b fSLEEP e · jG{-
fij d qOL r "j d AUI - X E a ozU b · d dOG < e · UN
d 'c · w W uH; W u d* · WD; WH 'u0 r "u · d · "vK UL W E · uB 'qO
fi'-· W H w u · d · v - UL 70MIN ← 80MIN ← 90MIN ← *AUTO

vK VOLUME "U H VOL e · j2{-
fi'uB · Øu j C ' UN' bF E^ WIO ØozUIK AUI · l{E · UEM ·
fiw U(· j dA · E^ WO U(· W 'u d · v

dNE v CLOCK/TIMER SET e · j3{-
fiDAILY SET U F · jG{- wJ

fENTER e · j4{-
fiW U · UO ON f u EU f dNE UO dJ SLEEP u Be · AUI · X E dOG

fiqOGA · b X 5 j {-
<W U · j C fENTER e · jG{- r dNE v dJ SLEEP u Be · uM · X R WHO E wGK
fENTER e · jG{- r fiSLEEP OFF U F ·

<ozU b · j C fENTER e · jG{- r
fiozU b · UO i u fiAUTO f d · - · - wI · X u · *s oI ·

uD)U · · · d · fH U U qOGA 6 AUI - X E j {-
f5

dNE v dJ fENTER e · j7{-
fi"u d* · wIO u* · bB* ·
UL W E · uB dF · dOG < e · UNO jGC d q
"wK

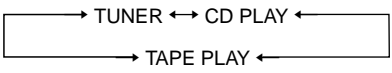

fENTER e · j8{-
b u E · b · DAILY f r X R* · u dNE
dF · dNE r <VO d U vIO u* · bB E AUI ·
fiwK ·

fi UEM · qOGA / b e · j9{-

u ~ · d · Z · d X R* · qO Ød _ qOGA · 'UOKL

X E s`b d · c · w W uH u ~ · WD qO PMJ1 e · j6 { j C · l { L s oI
fi`b .CLOCK/TIMER SELECT

d · c · w u ~ · d L ^ WD < XHR*U qO dJ >>> H <<< e · j2 { -
'- † W H w d · c · w u ~ · d · jG r DAILY U F · dNE v
fi', W H w W U · j { dE - a W U · j { ENTER e ·

UL · dE - a d · c · w W uH; 1 WD; WH 'u0 r e · j6 { - X R* · wGK
fi' - W H w d · c · w W uH WD fCLOCK/TIMER SELECT

.CLOCK/TIMER SET e · j2 { - dJ >>> H <<< e · j2 { -
fi DAILY SET U F · dNE r TIMER OFF U F · dNE v
ENTER e · jG { -

UO dJ >>> H <<< e · jG { -
fENTER e · jG { REC SET

fi W U · UO ON f u EU f · dNE fib 'L ' w X R*U qO 'L w uO · X R*
uJ < X u ' fH w uM ' X R L w · uO ' X
fi qOGA · `b X 4 j { - fi uM ' X R* W u L _
< W U · j C >>> H <<< Be · jG { - X R* · joAM PMJ1 s ux C* · X u ' w · UN' ' q
fENTER e · jG { - r fiv uO ' ·

fiozU b · UO i u boH ~ U -
< ozU b · j C >>> H <<< e · jG { - fBI u C* · X u ' s WO U - q qOGA ·
fENTER e · jG { - r

uD) U · · · · d · fH U U qOGA 5 AUI - X E j { -
f4

W uH; · u ~ · d · WD L AUI · b u L `b · b u dNE
fTUNER FM 5 f " U a UNKO ~ · d* · d · c · w
fiwK _ · dF · dNE r < VO d U

fB UN' · w TOK qO · sJ1 Ec 6 j dA · qOL r
fi UEM · qOGA / AUI e · jG { -

1

X R* ·



dF ' qOGA

Ød _' qOGA ' 'UOKL

WO U ' WOKLF ' USS r wJ

e ' jG{ j C ' l{L s oi

.CLOCK/TIMER SELECT

dJ ►►B H◄◄ e ' jG{-

bI ' kH—l{L < REC SELECT U F ' dne v

ENTER e ' jG{- r

dF ' W U iO LEL `U{-α w UC ' dF ' qH sJf1 r uD) ' s jBC' l{L dOG

d L 'qOGA ' AUI - l{L w UEM ' U - v e ' jG{- X R* ' wGK

l{Lα `bF ' l{L `UM ^ WJKN *' bI ' CLOCK/TIMER SELECT

fi' bI ' kH dJ ►►B H◄◄ e ' jG{-

qOGA AUI - `UM ^ **DISPLAY** uB ' jG{- r TIMER OFF U F ' dne v

fiW U ' d L^ w UC ' dF ' wH -v UEM

bI ' kH l{L `UG 'UE

d q fi UEM ' **DISPLAY** e `UMjG{- fib 'L ' w X R*U qO 'L w uO ' X R* 'L X R*U qO

"wK UL W L^ uB dF ' dOG fh < w e .UM X B L w uO ' X R* 'L X R*U qO

l{Lα d ~~bb~~*W U ' ←d w UC ' dF ' qO ' jOAM uMj1 su C* X u ' w .UN' ' qOGA

' bI ' kH fiX R*U

fiUND C XL ' - jI *w U ' dF fiqO ' `UM ^ sJ2 b q ^ v - *uB ' Øu

WE

fi bI ' kH l{L w WO U ' qOGA ' 'UOKLF UOI ' pMJ1 s

W U ' j { >

WBB< ' ' `u* ' AM W u*α U - WK d doOG >

'5 KH 'L j L_ ' dW LLHJO L L

WHO u ' ' ^ vK jGC U UEM ' qOGA >

bOH `U -

fi bI ' kH l{L w X R* ' qOGA dL

(CD) s LUMF 'L wKJ ' UL ' xWl wruDd ' s ' U uKF* ' ' .

dF ' W U vK

fiEUI ' l{DISPLAY e ' jG{-

"wK UL W E~ uB dF ' dOG < e ' UNO jGC d q . w U(' U LK wI * . X u 'L UL ' X

E~UF ' UL ' l{E w WLJ; ' W ' u ' uJ U bM fiW ' uD E^

wKJ ' 'U u *_ TOC E~U u ; ' Eb d

← * w U(' u wKJW ' uB U E^

d R* ← W U ' u , b* a ← U* ' u d ' r - (CD/MP3) s LUMF 'L wI * ' X u ' .

~bF ' <WO U(' W ' uD ' r = TOC * U u ; ' Eb fiE~UF ' UL DISPLAY ^ e ' jG{-
wKJ ' UL ' X E L W ' uD ' vK ' u u * ' ' U LK wI wKJ

fiW ' uD "wK UL W E~ uB dF ' dOG < e

b MP3 WO u ' ' U vK E u % w * * U ' uD W M U

fi UL ' l{E~W - u _ s LUM dF WLJ W ' uD - v - ' L ' b

' UE U LK wI ← w U(' U LK wCIM* ' UL

' ' U vK E u % w ' W ' uD wKJ ' UL d X ← * dF WO U(' W ' uD ← W I* w ' U X ' u ' .

fMP3 WO u d R* ← W U ' u , b* a W U

fi ' b ' vK jD3 w D D ' † s d ^ vK Øu Z U d v - UL ' bM

ID3 W UD ' ' U u MP3 n r ID3 W UD ' u E bM fiWIO ~ - E^ U

fi U ' uMF fiz d * ' UL ALL DISCS w < > fi > * dNE

X E L wCIM* ' UL ' X E dF ^ s l <WO U ' ' U(' w MHC-GX45/ ' ' u MP3 v - UL ' bM

fiWIO ~ uB wI * ' U > MHC- GX35/RG440S/RG330/RG310

fi(VBR) dOG XCOMP3 b v - UL ' bM > MHC- GX35/RG440S/RG330/RG310

fi l d ' lo d ' E^ .bI ' `UM' jI > ' WO E d ' E WO E RG220 ' u * ' a

U LK wI ← w U(' U LK wCIM* ' UL

' u ← * WO U(' W ' uD ← W I* w ' U X ' u ' .

← ' ' u , b* a W U u ' d ← * ' U * ' .

d R* ' W U

† s d ^ vK Øu Z U d v - UL ' bM

fMP3 WO u ' ' U E^ WIO ~ - F

E^ Z d * ' UL ALL DISCS w < > fi > * dNE

fMP3 WO u ' ' U v - UL ' .

l ' b ID3 W UD ' vK Øu U * ' v - U

ID3 W UD ' ID3 W UD ' l . b M C O < ' b ' a

fijI U * ' ' uM ' U U

CF

bI ' `U{- d00

MHC-GX45/GX35/RG440S/ ' ~u*' 'α

' ~u***MHC-RG220** ~~**RG330/RG310**~~

' jI 'WO EdWOLL E_'

ILLUMINATION e ' jG{-

"wK UL W E~ uB bI ' `U{- d0G e

MHC-GX45/GX35/RG440S/RG330/ ' ~u*' q ^ s
RG310

← PATTERN 3 ← PATTERN 2 ← PATTERN 1

← PATTERN 5 (FLT) ← PATTERN 4

' d E d PATTERN OFF

'WO EdWOLL E_ ' ~u***MHC-RG220** q ^ s

' d E b α ← HqOGA

fi UN q l WI d** qOGA . . . ^ U - l . fiw UO - eN ^

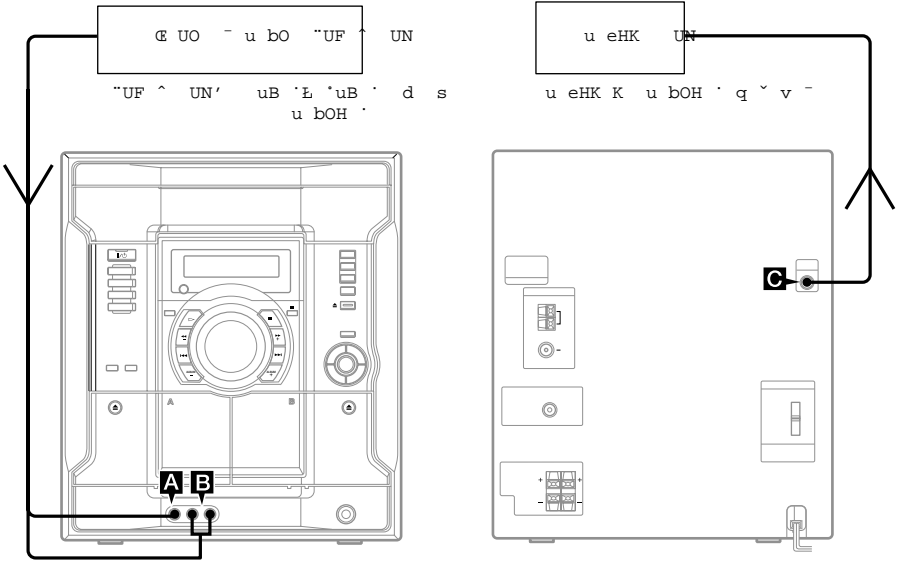

W UO

GAME INPUT VIDEO f I A

U '- v u eHK ' W U vK u bOH ' "UF ^ UN u u dNE d b qO u 'o d dO a u
 fH u UEM . UN u bOH dNE d b qO u 'o d dO a u
 vK EdF K - , W H w W U ' u d R UO - de f I * ' c v - E UO ' u l
 fiu bOH ' "UF ^ ' u ' do Q

GAME INPUT AUDIO L/R f UI B

qOGA r < tKOGA EU I GAME M J C U L ' v K
 v - ' u * ' u GAME a E WHO u ' u E < UN ' u B ' d qO u ' WI d dO a WO u
 f I GAME EQ
 < UEM ' qO GAME M GAME (MD) XDG { v -
 v O z U I K ' GAME u v - L WHO u ' u
 fi UEM ' c s ' u B ' v -

VIDEO OUT f I C

UM MHC R G 2 2 0 MHC - G X 2 5 ' v u * ' q * ^ s
 ' W O L d ' O H E ' v u *
 u eHK K u bOH ' q ^ qO u ' o d dO
 f I I * ' c v -

fix R*fi d'c' w u' d' UD kh flv

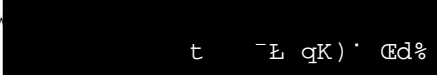

t -L qK) Ed%

'-t WH a d'c' w u' d' UD kh

>"d I* F' L q UA

't- WH a j C' l{L s oI%

't- WH a u' d' Z' d X R* qK U qLF r < UEM 'c ULF - w

fi'u bB WI dD WK u W UL ' a ^L UO 1 qO u PK

vK VOLUME ^U H d EXOL -L' jG{-

fi UJ S E W O

fiW U ' UI ' L' U^ w UN''

fiWK u do ^d' U UL ^Cp Q^ U ^ W {u* qK) Ed% qO ^ 2LzU w W

fi5 * 'O B ' d -

fi' W H a W UL ' O u s oI%

fix R*U qO ^ UM ^ u' d' u' B B "d ^ dA - < o U q qL bF WKJA

fiP b w u

Ød o ' 5 UMI ' s ^UB ' uJ E^ < b' E UM s bB 'uB

I/O d R* i u U bM

fiW 'u do vMLO 'L

fi UJ ' b WK UL WI dD ^U UL ' l{fiWO U ' ^UM ' h ' L U(w UC

fiWI d* ^U UL ' qO u r

fiOH) ' dON' tBIM 'uB ^W O B ' WOD uH ' vK u C WOD uH ' UO

WI dD W U W E u* ^U UL ' f UI ^ qO u s oI% UO - ^U H ^ b Q r < p IDM0 W U) ' WC

fiW O

fiW O WI dD u C WOD uH

fi b b ^U{u{ L^ e ^ b u ^ W U W E u* W UL ' a _ dB ^ dz ^ X b

fi^U{u C ' bEoB UEM ' p d r ^ jI UN w u* ^U UL ' b

fiJzU(U nK UO c Q ^ UEM ' qOHK) rWN' vK ^ u u* W uN ' ^U H

UO ' j v ' u _ w ^U a ^ U{u{ ' d VO d r ^ UEMK

fiW Ozd ' r < WKJA E^ q L ^ W {u* ^UM ' s

fix R* j { sJ1 iO E dL - - - fi UEM ' qOGA E Ød ^ d

fi', W H a Ød ^ d W U ' j WKJA* V vK u F ' s sJL ' b W

fiqLF X R* w u u "d ^ dA - < ^ ^UM ' LOL

fiP b

w H a 'O B ' X u ' j {L X R* j { U{L^ s oI%

fi'tt L t-

W U

fi't W H a uM ' X R ^WHO L ^UG S r rI r ' v d U UO ' pK qO u VI iO

fiqLF bF s rJ ' b Efi' W H a UEM 5 rVO duD) sde - UEM ' qO

fiozU E^ W ' S r wH fi UEM ' qOGA DISPLAY uM ^ 5 q -

fi UEM ' sL bF s rJ ' b E ^ d fiw UC ' dF ' fi UEM ' dFA v - bF s rJ ' b E tO u r fi dF ' W U - vK - e dNE

fiAA r R6a ^U UD ' b j { U{L^ L ' W H a W U ' j { fi UO K U

fiXM uKH ' uOF s UEM ' l{ fiØd ^ d 'tt L t- w H a X R*

fiWO u WOF W cG b u

fi'uB ' Eu iOH r

fi u eHK ' W U vK W ^UF ' do W uK* uB ' d 'dL -

t v - - E d bF tKOGA b ^ r ^ u eHK ' UN qOGA n E^

s ^bOF ^U UL ' l{ < W ^UF ' do 'u _ ' dL - - - fiWIO ^

fi u eHK ' UN

qzU

`UM ^ dF ' W U vK WO U ' qzU d .
fiqOGA ' .

fiu d l{L wFMuzd'd UI - sJ1
STEREO/MONO e FM LMODE e ' jG{-
~u* ' `MHC-RG220 MHC-GX25 q ~uLK
Øb fiMONO: E ^ dNE: jh WO E ' WO Ld ' L

MP3fiWLJ; ' W 'uD ' .

XO UJ ' W d ^ UN

NO DISC

fiqGA* ' w WLJ W 'uD - b u

fi'uB ' Øu iOH r E^ to - UL ' E^ j dA
fi'† W H □ UNHOEM r • <W E~d

OVER

▶▶ e ' jG{ `UM ^ W 'uD ' W UN v - XK E X ^
fiX R* ' nO u ' E^ UL

W ' S r fiWO ODMG V 'L UN • UL ' flqO
fi'† W H □ UNM WO O UMG* ' .

fiU9 j dA ' ' r
W ' S r fiWO ODMG V 'L UN • UL ' flqO
fi'† W H □ UNM WO ODMG* ' .

fi'uB ' w LDI E^ s bz' UIH E^ 'UI
fi'† W H □ UNHOEM r fiW ' • dJ ' E^ d

fiWO UF ' ' ' ~d ' ' r E^ `U{
W ' S r fiWO ODMG V 'L UN • UL ' flqO
fi'† W H □ UNM WO ODMG* ' .

fi j dA ' vK qO ' r
fiXO U qOL r fiXO U qOL% r
j dA u J* ' U K ' WODG r fiXO UJ ' s
fi'† W H □ o
fit UN v - j• dA ' q E

' ' ' d U UOI ' bF W O uB qLF UEM
"wK UL UEM ' j { b ^ <WI

fi UO ' pK1 qB -
fiØd ^ d UO ' p2 qO u b
fiX u ' fiU/OW GROOVE ■ ' _ 3G{-

fi UEM ' iQGA e ' 4{-
j { V fiLMB* ' j { U{E^ v - UEM ' j
w u ~d ' 'UD kH q <UNKLF XL w
fiX R* 'L W U ' < d ' c

° UH · u* ·

qJON · nOEM

WKK WL U UL WFDI rJ ' ' O UH £ dF ' ' u
u £ W U (' U UA (' s u £ ^ BOK fib F
fi u J ' £ ^ s e M ' £ ^ d M ' q ' U

' uB · r C r

" WO ULA · UJ d _ WBB < ' ' u* ·

WLz · uB j dA · kH (

MHC-GX45

A t u ' s XO UJ ' U d - < QD ' o dD j dA
fiqJA ' w 5 B t u uL £ ^

WO U _ W UL

bm £ ^ ¶ a ' ' £ - † « - †
wK wI ' u t uA < e d uKO -
' £ -
uKO - bm £ ^ ¶ a ¶ \ · swK ^ wI ' u ·
' ' £ ¶ < e d

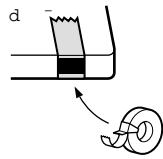
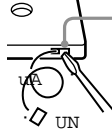

w dH ' WCH M* ' ' ' d
' ' WF ' d a RMS * d ' b
< e d ¶ bm £ ^ ¶ a ' ' £ - †
' £ - wK wI ' u t uA
bm £ ^ ¶ a ¶ \ · s qwKJ ' wI ' u · uA

U K ' WODG r < qO K j dA ' ULF - ' v
fio j dA u J* ·

MHC-GX35

bm £ ^ ¶ a ' ' £ - † « - †
wK wI ' u t uA < e d uKO -
' £ -
uKO - bm £ ^ ¶ a ¶ \ · swK ^ wI ' u ·
' ' £ ¶ < e d

W d _ UN w XO U U ^ - q
w p UA ^ sJl j dA ' S - £ fij dA ' w
fithK v - £ R U2 W d _ UN ' WOK

WIO ^ " s u ^ j d ULF -
< UL ' q j dA ' qOGA ' UOKL dOOG rI
UN w j dA ' p UA ^ sJl fi dJ uB l
fiw d _

MHC-GX25

bm £ ^ ¶ a ' ' £ - † « - †
wK wI ' u t uA < e d uKO -
' £ -
uKO - bm £ ^ ¶ a ¶ \ · swK ^ wI ' u ·
' ' £ ¶ < e d

j dA ' £ ~ nOEM
nOEM s b Q fiqOGA ' U U - q bF j dA ·
j d v - UL ' bF £ ^ W UN ' ' u* · qO
fPBHM U £ c ' qK * ' £ ^ £ U ' ' uM ' s nOEM ·
uA ' fi nOEM ' XO UJ W U) ' * ULOKF ' l ' < qO

j dA ' £ ~ WO ODMG W · -
j dA ' f w ' WO bF * ' ' e _ £ j dA ' £ ~
WO ODMG * ' W ' - XO U ULF U qOGA ' s W U
XO UJ W U) ' * ULOKF ' l ' ° BHO UHU ' £ c b e *
fiwo ODMG * ' W ' -

W UL

'U 'uD ' qGA r

"WO ULA ' UJ d ^ Eb WBB< ' u*
SS-RG440 WO U _ W UL

'u L WLJ W 'uD - UE UEM
wL
q u t eO eOK
'd u =λ
qB " UF ' s

MHC-GX45/GX25

'd <'b E ‡ <'U U&- ‡ W UL ' UE
DON'' 'uB ' UJF -

e d uKO † > e d f' d K W U
'q O ±α\

r - ‡ w Ed u "WCH M* ' ' d UN
r - ‡ w Ed "wudH ' WCH M* ' ' d UN
r w Ed u "WO UF ' ' d UN

d u U " > , W u* ' u
q O " s d ^ZO CK U ' W
q O " s d ^ wJO UM b ' U:

U dI 3 † " † † 'bL†fl UH -fl d α 'UF
W UL UJ DI w U r '\ † u

W d _ UN r
< 'q O ±α † > U
'uM ' s w u XO U ULF U

q 'u SS-WG990 w dH ' WCH M* ' ' d
MHC-RG45

UN TYPE 1
fo UI*U α E c ± bM ¥ \-UF ' E ' EUH

dON'' 'uB ' UJF - 'd W UL ' UE
W UL ' 'b E fo UI*U RMS bM ¥ \-

IEC
fo UI*U RMS bM ¥ \-

r † w Ed u "WCH M* ' ' d UN
E^ † WOL ' W EUI*

fo UI*U α E c ± bM ¥ \†
DIN

U dI 3 † " † † 'bL†fl UH -fl d α 'UF
W UL UJ DI w U r '\ u

n 'u* r

"bMJ WBB< q 'u*
MHC-RG35 q 'u SS-RG660 WO U _ W UL

s 'Ed OFM/AM <u FM n 'u
FM W u* n 'u r

'd <'b E ‡ <'U U&- ‡ W UL ' UE
DON'' 'uB ' UJF -

WH 'u* U
e d UGO ..\ > † \UO Ed hb< q 'u*

r - w Ed u "WCH M* ' ' d UN
r - w Ed "wudH ' WCH M* ' ' d UN
r w Ed u "WO UF ' ' d UN

'u d do Q α aUM fo
e d UGO - , \ > , .\
UN e d UGO - , \ > , .\ Ød _ ' ' u*
FM w uLK wJK wz 'u wz 'uN

U dI 3 † " † † 'bL†fl UH -fl d α 'UF
W UL UJ DI w U r '\ u

'u do E^ . wz 'uN ' qO u E' d ^
e d UGO - \ . j u * ' d

AM W u* n 'u r

WH 'u* U

"WOJ d _ EbK WBB< ' ' u*

WK d l α e d uKO -- > †
uKO - vK W u C* W u* WH 'u
'e d

WK d l α e d uKO -- > †-
uKO " vK W u C* W u* WH 'u
'e d

"5 KHj 'E_ dA 'E UO E E U E E^ Eb WBB< ' ' u*
WK d l α e d uKO -† † > †-
uKO " vK W u C* W u* WH 'u
'e d

WK d l α e d uKO -- > "Ød _ ' ' u*
uKO - vK W u C* W u* WH 'u
'e d

WK d l α e d uKO -† † > †-
uKO " vK W u C* W u* WH 'u
'e d

AM w uLK wIK wz 'u wz 'uN
w U)' wz 'uN ' qO u E' d ^
e d uKO . j u * ' d

u .
 "WO ULA . UJ d ^ Eb WBB< .
 Ø dI r "\ HCD-GX45
 Ø dI r "\ HCD-GX35
 Ø dI r "\ HCD-GX25
 "WO Ed 'E WO E E_ . ' ~u*
 Ø dI r "\ HCD-RG440
 Ø dI r "\ HCD-RG330
 Ø dI r "\ HCD-RG310
 Ø dI r "\ HCD-RG220
 "Ød _ . ' ~u*
 Ø dI r "\ HCD-RG330
 Ø dI r "\ HCD-RG220

'-a bF s rJ% b E "WI d* 'UI K*'
 '†a *U UD
 '-AM w uLK wJK wz'u
 '-FM w uLK wJK wz'u
 W UL 'UOA
 MHC-GX45/RG440S
 '-†a
 MHC-GX35/GX25/
 RG330/RG310/RG220
 ',a

fi UF - Eb doOG K W{d 'UH 'u*'E

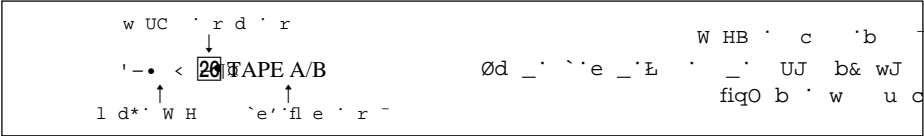

WO Ozd ° b u

° _ n L

eb ^ vo d

- | | | |
|---|---|--|
| <p>13 UNPUSH</p> <p>15</p> <p>15</p> <p>20</p> <p>20</p> <p>22 UNPUSH</p> | <p>23 REC PAUSE/START</p> <p>26 TAPE A/B</p> <p>27 FINDER/BAND</p> <p>5</p> <p>21 A UN</p> <p>14 B UN</p> <p>4 dF ° W U</p> <p>7 ° U ° uD ° WOMO</p> <p>3 bF s rJ ° b L dFA</p> <p>16 VOLUME ° U H</p> <p>GAME INPUT AUDIO L/R f UI</p> <p>19</p> <p>18 GAME INPUT VIDEO f I</p> <p>17 PHONES f I</p> | <p>15 ALBUM +*</p> <p>20 ALBUM -*</p> <p>28 CD</p> <p>24 CD SYNC</p> <p>8 DISK 1-3</p> <p>9 DISC SKIP/EX-CHANGE</p> <p>2 DISPLAY</p> <p>11 EFFECT ON/OFF</p> <p>25 GAME</p> <p>12 GAME EQ</p> <p>12 GAME MIXING</p> <p>12 GROOVE</p> <p>12 MOVIE EQ</p> <p>12 MUSIC EQ</p> |
|---|---|--|
- MHC-GX45/GX35/ ° u°*
- ERG440S/RG330/RG310
- WO L E ° ° uMHC-RG220
- jI ° WO L d ° L

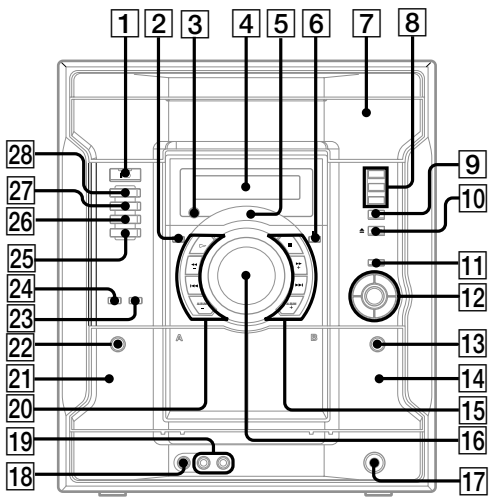

MHC-RG440S MHC-GX45

Subwoofer

1 SUB WOOFER ON/OFF

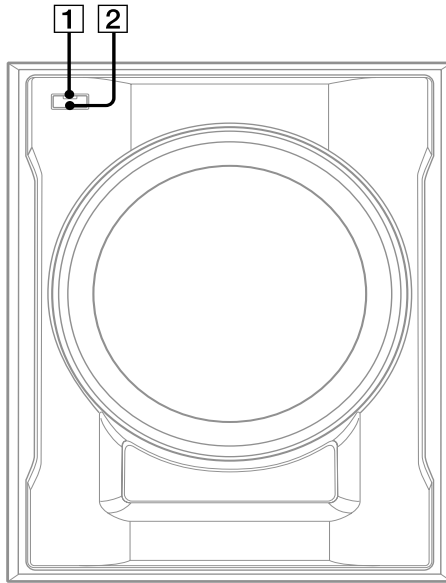

↑, < ↑ < ↑ 4 ↑ W
 5 'lo d 'fl d
 u d 'fl U
 ↑ < - ↑ < - ↑ 5 ↑ nK < K
 ↑ < 5 ↑ UL
 ↑ < 5 ↑ X R n
 ↑ < - ↑ 5 ↑

WHO E v - q u K *e ' c
 fGAME "UF -

Z-I

↑ 15 ILLUMINATION
 ↑ < - ↑ 20 PLAY MODE
 ↑ < 17 PRESET EQ
 ↑ < 5 PRESET -/+
 ↑ < 21 REPEAT
 ↑ 2 SLEEP
 ↑ < 11 SURROUND
 ↑ < 9 TAPE A/B
 ↑ < 18 TUNER/BAND
 ↑ < 8 TUNER MEMORY
 ↑ < 5 TUNING -/+
 ↑ < 12 VOL +/-

H-A

↑ < 14 ALBUM +/-
 ↑ < - ↑ 19 CD
 ↑ < 5 CLEAR
 2 CLOCK/TIMER SELECT
 ↑ < ↑ < 3 CLOCK/TIMER SET
 ↑ < ↑ < ↑ 6 DISPLAY
 ↑ < 7 D. SKIP
 ↑ < ↑ < - ↑ 16 ENTER
 ↑ < 21 FM MODE
 ↑ < 10 GAME (MD)*
 ↑, < 13 GROOVE

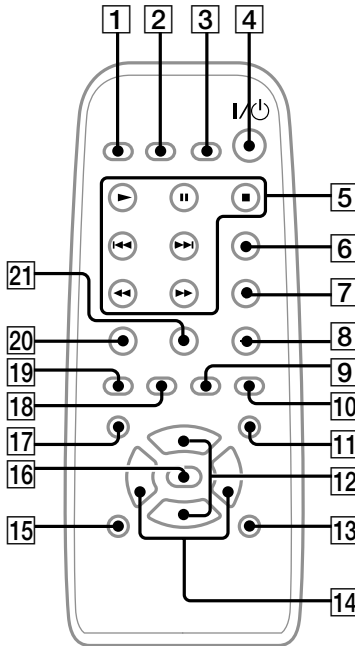

WO U{- 'U u

_____ n E

_____ VO d

't, < +¶ < t [4] ±W dZα
 [5] 'lo d 'fil d ◀▶/▶▶▶▶
 '¶ \- α
 u d 'fl U ◀▶▶▶▶▶
 't < -¶ < -t [5] ±nK<K, α
 '¶ < [5] α ' UL ▶▶▶▶
 '¶ < [5] α 'X R n d||u α
 '· < -¶ [5] - ±u i α

Z - O

'-, [16] ON/OFF
 '¶ < -t [21] PLAY MODE
 '·- < [5] PRESET -/+
 '·- [8] REPEAT
 't [1] SLEEP
 '· [6] STEREO/MONO
 '·, [11] SURROUND
 '·- < [9] TAPE A/B
 '·- < ·- [18] TUNER/BAND
 '·-t [17] TUNER MEMORY
 '· < [5] TUNING -/+
 't < [12] VOL +/-

N - A

'·- < -t [19] CD α
 '·-t [20] CLEAR
 [2] CLOCK/TIMER SELECT
 't t < t- α
 < t [3] CLOCK/TIMER SET
 't-
 't t < t t [6] DISPLAY
 '· [7] D. SKIP
 't- < t < -t [15] ENTER, α
 '·, [14] EQ +/-
 't < [10] GAME
 't, < [13] GROOVE

