

# Micro HI-FI Component System

## Operating Instructions

### WARNING

To reduce the risk of fire or electric shock, do not expose this apparatus to dripping or splashing, and do not place objects filled with liquids, such as vases, on the apparatus.

To reduce the risk of fire, do not cover the ventilation opening of the apparatus with newspapers, tablecloths, curtains, etc. Do not place the naked flame sources such as lighted candles on the apparatus.

As the main plug is used to disconnect the unit from the mains, connect the unit to an easily accessible AC outlet. Should you notice an abnormality in the unit, disconnect the main plug from the AC outlet immediately.

Do not install the appliance in a confined space, such as a bookcase or built-in cabinet. Do not expose batteries or apparatus with battery-installed to excessive heat such as sunshine, fire or the like.

The unit is not disconnected from the mains as long as it is connected to the AC outlet, even if the unit itself has been turned off.

### CAUTION

The use of optical instruments with this product will increase eye hazard.

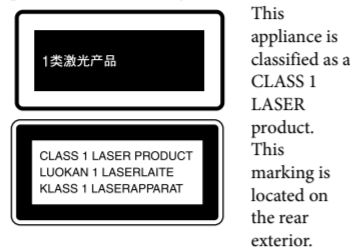

### Licences and Trademarks

- This system incorporates Dolby® Digital.
  - Manufactured under license from Dolby Laboratories.
  - "Dolby" and the double-D symbol are trademarks of Dolby Laboratories.
- MPEG Layer-3 audio coding technology and patents licensed from Fraunhofer IIS and Thomson.
- Windows Media is either a registered trademark or trademark of Microsoft Corporation in the United States and/or other countries.
- This product contains technology subject to certain intellectual property rights of Microsoft. Use or distribution of this technology outside of this product is prohibited without the appropriate license(s) from Microsoft.

- ABOUT MPEG-4 VISUAL: THIS PRODUCT IS LICENSED UNDER THE MPEG-4 VISUAL PATENT PORTFOLIO LICENSE FOR THE PERSONAL AND NONCOMMERCIAL USE OF A CONSUMER FOR DECODING VIDEO IN COMPLIANCE WITH THE MPEG-4 VISUAL STANDARD ("MPEG-4 VIDEO") THAT WAS ENCODED BY A CONSUMER ENGAGED IN A PERSONAL AND NONCOMMERCIAL ACTIVITY AND/OR WAS OBTAINED FROM A VIDEO PROVIDER LICENSED BY MPEG LA TO PROVIDE MPEG-4 VIDEO. NO LICENSE IS GRANTED OR SHALL BE IMPLIED FOR ANY OTHER USE. ADDITIONAL INFORMATION INCLUDING THAT RELATING TO PROMOTIONAL, INTERNAL AND COMMERCIAL USES AND LICENSING MAY BE OBTAINED FROM MPEG LA, LLC. SEE <http://www.mpegla.com/>.
- All other trademarks and registered trademarks are of their respective holders. In this manual, ™ and ® marks are not specified.

### About this manual

- "DVD" may be used as a general term for a DVD VIDEO, DVD-R, DVD-RW, DVD+R or DVD+RW.
- CD-R or CD-RW is sometimes referred to as "DATA CD."
- DVD-R, DVD-RW, DVD+R or DVD+RW is sometimes referred to as "DATA DVD."
- This manual mainly explains operations using the remote, but the same operations can also be performed using the buttons on the unit having the same or similar names.

### Playable Discs

DVD	DVD VIDEO DVD ROM DVD-R/DVD-RW* DVD+R/DVD+RW*
CD	CD-DA (Music CD) CD-ROM CD-R*/CD-RW* VIDEO CD

\* If discs have not been correctly finalized, they will not be played back. For more information, refer to the operating instructions supplied with the recording device.

### Discs that cannot be played

- Blu-ray Discs
- HD DVDs
- DVD-RAMs
- DVD Audio discs
- PHOTO CDs
- Super Audio CDs
- Data track of CD-Extras
- Audio material side on DualDiscs
- DVD-R/DVD-RW/DVD+R/DVD+RW in VR (Video Recording) mode
- CPRM (Content Protection for Recordable Media)-compatible DVD-R/RW containing content flagged as "Copy once."

### Music discs encoded with copyright protection technologies

This product is designed to play back discs that conform to the Compact Disc (CD) standard. Recently, various music discs encoded with copyright protection technologies are marketed by some record companies. Please be aware that among those discs, there are some that do not conform to the CD standard and may not be playable by this product.

### Playable File Types

File format	Extensions
Xvid video	"avi"
MPEG4 video <sup>1)</sup>	"mp4" or ".m4v"
<b>Music</b>	
File format	Extensions
MP3 (MPEG1 Audio Layer 3) <sup>2)</sup>	"mp3"
WMA <sup>3)</sup>	"wma"
AAC <sup>4)</sup>	"m4a"
<b>Photo</b>	
File format	Extensions
JPEG	"jpg" or ".jpeg"

<sup>1)</sup> Supported video and audio codecs are as follows:  
— Video codec: MPEG4 Simple Profile (AVC is not supported.)  
— Audio codec: AAC-LC (HE-AAC is not supported.)

<sup>2)</sup> MP3 PRO format is not supported.  
<sup>3)</sup> WMA DRM, WMA Lossless and WMA PRO formats are not supported.  
<sup>4)</sup> AAC DRM and AAC Lossless formats are not supported.

- Notes**
- Some files may not play depending on the format, the encoding method or recording condition.
  - Some USB devices may not work with this system.
  - The system supports ISO 9660 Level 1/Level 2 and Joliet for DATA CD.
  - The system supports UDF (Universal Disk Format) for DATA DVD.
  - The system supports FAT12, FAT16 and FAT32 for USB device.
  - The system can recognize the files or folders on a DATA DVD, DATA CD or USB device as follows:
    - up to 300 folders
    - up to 648 files
  - It may take time to read files in the following cases:
    - there are too many folders or files.
    - the memory capacity of the USB device is very large.
    - the memory of the USB device is fragmented.

### Compatible USB devices with this system

You can use the CCC-certified USB devices with this system.

**Note on the usage of CCC-certified USB devices**  
Compatibility with CCC (China Compulsory Certification)-certified USB devices on this system is not fully guaranteed. This is because the USB device specifications may differ depending on the manufacturers. For more information on how to use a USB device, see the operation manual supplied with the USB device.

### Preparing the remote

Insert the two R6 (size AA) batteries, matching the polarities as shown below.

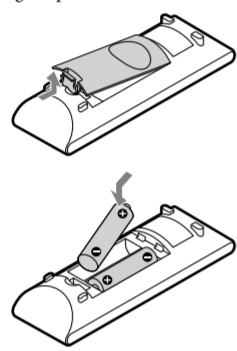

### Hooking up the system securely

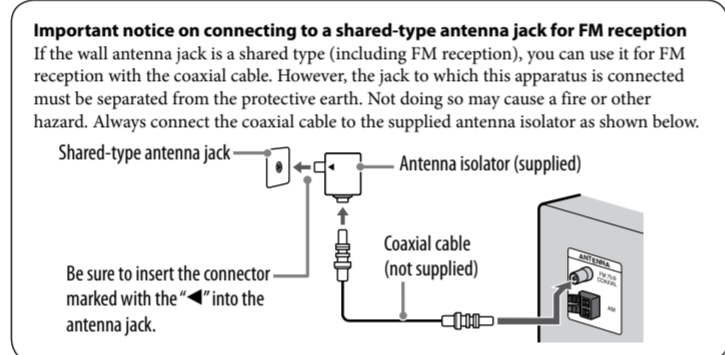
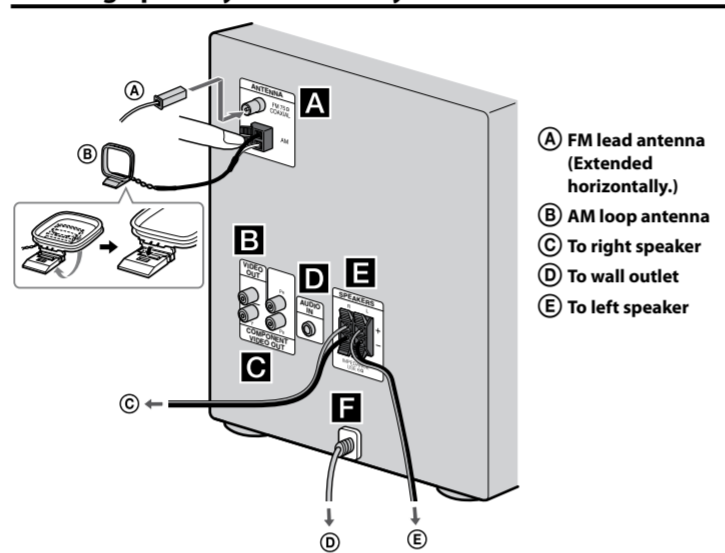

### Antennas

Find a location and orientation that provide good reception when you set up the antennas. Keep the antennas away from the speaker cords and the power cord to avoid picking up noise.

### VIDEO OUT jack

Connect the video input jack of the TV or projector.

### COMPONENT VIDEO OUT jacks

Connect the component video input jacks of the TV or projector using the optional component video cords for higher quality video images. If your TV accepts progressive signal, see "Progressive" (page 21) to set the progressive scan mode.

### AUDIO IN jack

Connect an optional audio component.

### Speakers

Insert only the stripped portion of the cords.

### Power

Connect the power cord to a wall outlet. If the supplied adaptor on the plug does not fit your wall outlet, detach it from the plug (only for models equipped with an adaptor).

### Attaching the speaker pads

Attach the supplied speaker pads at each corner on the bottom of the speakers to prevent them from slipping.

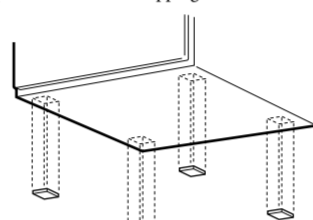

### Connecting your TV

Connect the video input jack of your TV to the VIDEO OUT jack on the unit, using the supplied video cord.

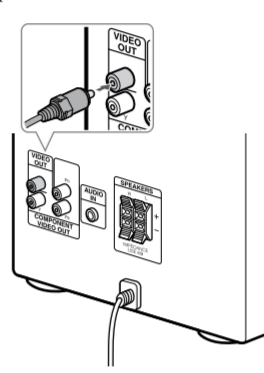

### When connecting a video deck

Connect the TV and the video deck using video and audio cords (not supplied) as shown below.

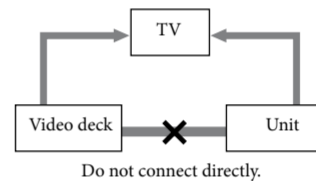

If you connect a video deck between this system and the TV, you may experience video leakage when watching the video signal from this system. Do not connect a video deck between this system and TV.

### Color System Setup

Change the color system if necessary from [PAL], [Multi] or [NTSC] after connecting your TV. The factory default of the color system is [Multi].

- Connect the power cord to a wall outlet.
- Press I/O to turn on the system.
- Press FUNCTION repeatedly to switch the function to DVD/CD. Playback starts automatically if a disc with an auto playback function is loaded. Press [ ] (or CANCEL [ ] on the unit) twice to stop playback.
- Press SETUP in stop mode. The setup menu appears.
- Press +/- repeatedly to select [Preference Page], then press [ ].
- Press +/- repeatedly to select [TV Type], then press [ ].
- Press +/- repeatedly to select [PAL], [Multi] or [NTSC], then press [ ].
- Press SETUP to turn off the setup menu.

**Note**  
The display on the TV screen may be interrupted momentarily after changing the color system as described above.

## Parts and Controls

### Front panel

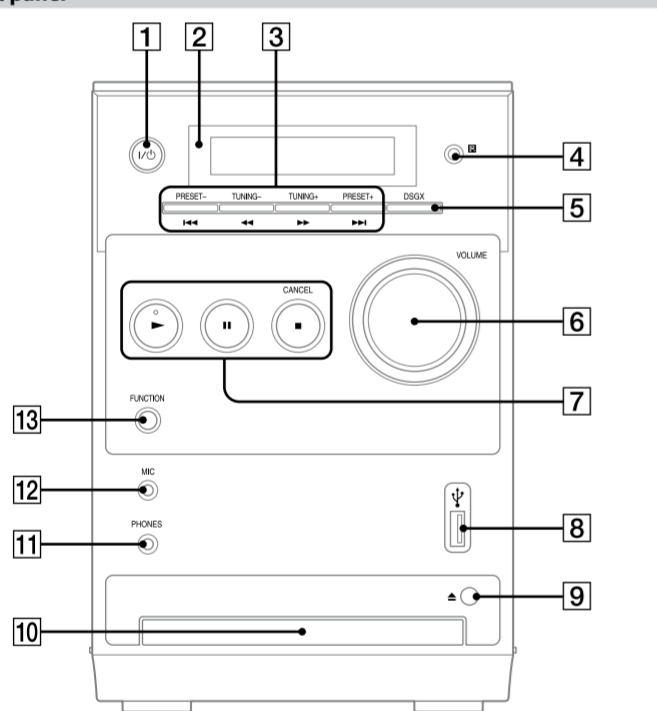

- I/O (on/standby) button**  
Press to turn on or off the system.
- Display**
- PRESET +/- button**  
Press to select a preset station.  
**TUNING +/- button**  
Press to tune to a desired station.  
**◀/▶ (previous/next) button**  
Press to select a track, file or chapter.  
**◀◀/▶▶ (rewind/fast forward) button**  
Press to find a point in a track, file or chapter.
- Remote sensor**
- DSGX button**  
Press to turn on or off the DSGX effect.
- VOLUME control**  
Turn to adjust the volume.
- [play] button**  
Press to start or re-start playback (resume play).  
**[pause] button**  
Press to pause playback. To resume playback, press the button again.  
**CANCEL [stop] button**  
Press to stop and remember the stop point (resume point). To re-start playback from the resume point (resume play), press [play]. Press to cancel the automatic tuning for a radio station.
- (USB) port**  
Used for connecting a USB device.
- [open/close] button**  
Press to open or close the disc tray.
- Disc tray**
- PHONES jack**  
Used for connecting the headphones.
- MIC jack**  
Used for connecting a microphone.
- FUNCTION button**  
Press to select the function.

### Remote

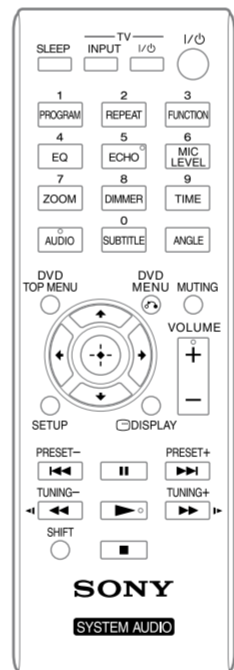

- SLEEP**  
Press to set the Sleep Timer.
- TV INPUT**  
Press to switch the TV's input source between the TV signal and other input source. Note that only Sony TVs can be operated using this remote.

- TV I/O (on/standby)**  
Press to turn on or off the TV. Note that only Sony TVs can be operated using this remote.
- I/O (on/standby)**  
Press to turn on or off the system.
- PROGRAM**  
Press to activate program play in the DVD/CD function, or press to preset radio stations in the tuner function.
- REPEAT**  
Press to activate repeat/shuffle playback mode.
- FUNCTION**  
Press to select the function.
- EQ**  
Press to select a sound effect.
- ECHO**  
Press to adjust the echo level.
- MIC LEVEL**  
Press to adjust the microphone volume.
- ZOOM**  
Press to zoom in or zoom out of a displayed picture when viewing a DVD VIDEO, a VIDEO CD, an Xvid video, an MPEG4 video or a JPEG image. You can move the magnified portion of the picture by pressing [ ]/[ ]/[ ]/[ ].
- DIMMER**  
Press to change the brightness of the display.
- TIME**  
Press to display or switch the time information during playback.

- AUDIO**  
Press to select an audio signal format when multiple audio signals are available. Press to select the FM reception mode (monaural or stereo) when listening to FM stereo programs. Press to improve the AM reception when an AM program has static noise.
- SUBTITLE**  
Press to select a subtitle language when multilingual subtitles are available.
- ANGLE**  
Press to switch to other viewing camera angles when multi-angles are recorded on a DVD VIDEO.
- Number buttons**  
Press to enter numbers for selecting a title/chapter, preset radio station, etc.
- DVD TOP MENU**  
Press to open the DVD top menu.
- DVD MENU**  
Press to open or close the DVD menu. When pressed during playback of JPEG image files, a thumbnail view (digest view) is displayed.
- MUTING**  
Press to mute or unmute the sound.  
[ ]/[ ]/[ ]/[ ]  
Press to move the cursor for item selection.  
[enter]  
Press to enter/confirm the settings.
- VOLUME +/-**  
Press to adjust the volume.

- SETUP**  
Press to open or close the setup menu.
- [DISPLAY]**  
Press to open or close the Display Menu.
- Playback operation buttons**  
[ ]/[ ]/[ ]/[ ] (previous/next)  
[ ]/[ ] (fast reverse/fast forward)  
[ ]/[ ] (slow reverse/slow forward)  
[ ] (play)  
[ ] (pause)  
[ ] (stop)
- Radio operation buttons**  
PRESET +/-  
TUNING +/-  
SHIFT

### Playing a Disc

- Press FUNCTION repeatedly to select the DVD/CD function.
- Press [ ] on the unit to open the disc tray.
- Place a disc in the disc tray, then press [ ] on the unit to close the disc tray. Playback starts automatically when you close the disc tray. If the playback does not start automatically, press [play].



- Press VOLUME +/- or turn VOLUME control on the unit to adjust the volume.

### Playing Files on a Disc/USB Device

- Press FUNCTION repeatedly to select the DVD/CD or USB function.
  - DVD/CD: For a disc.
  - USB: For a USB device.
- Load the source.
  - For a disc**  
Place a disc in the tray by pressing [ ] on the unit to open or close the disc tray.
  - For a USB device**  
Connect a USB device to the [ ] (USB) port.

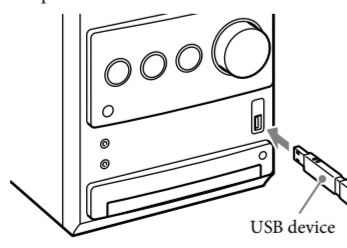

- Select a desired file from the displayed file list.
  - Cursor position number
  - Cursor
  - To move the cursor: Press [ ] or [ ].
  - To enter a folder: Press [ ] or [ ] after moving the cursor to a desired folder.
  - To return to the parent folder: Press [ ] or [ ] after moving the cursor to [ ]/[ ].

You can also check the current cursor position and its number from the following information that will appear on the display.

[FLD] XXX:  
Indicates that a folder is selected, representing its cursor position number (ex. "[FLD] 005").

[BACK]:  
Indicates that [ ]/[ ] is selected.

File format and XXX:  
Indicates the file format of a currently selected file, representing its cursor position number (ex. "WMA 002").
- Press [play] to start playback.
- Press VOLUME +/- or turn VOLUME control on the unit to adjust the volume.

### Other Playback Operations

- To change angles (only for DVD VIDEOS)**  
Press ANGLE during playback to select the desired angle.
- To display subtitles (only for DVD VIDEOS)**  
Press SUBTITLE during playback to select the desired subtitle language.
- To change the sound**  
Press AUDIO repeatedly during playback to select a desired audio format.

- When playing a DVD**  
When playing a DVD VIDEO with multiple audio formats, you can change the audio format from PCM, Dolby Digital or MPEG audio. If the DVD VIDEO is recorded with multilingual tracks, you can also change the audio language.
- When playing a CD/VIDEO CD**  
You can select stereo sound or monaural sound settings for sound output from the speakers. In monaural sound settings, you can select the right or left channel and listen to the selected channel sound through both the right and left speakers.

### To play a VIDEO CD with PBC functions

- When you start playing a VIDEO CD with PBC (Playback control) functions, the PBC menu appears for your operation.
- To play without using PBC**  
In stop mode, press and hold SHIFT, then press the number buttons to select the desired item number.
- To magnify the displayed picture**  
You can zoom in or zoom out of a displayed picture when viewing a DVD VIDEO, a VIDEO CD, an Xvid video, an MPEG4 video or a JPEG image. The magnified portion of the picture can be moved by pressing [ ]/[ ]/[ ]/[ ].

### To search for a title/chapter/track/scene, etc.

- When playing a DVD/VCD**  
1 Press [ ] DISPLAY during playback. The Display Menu appears on the TV screen.
- Press +/- to select an option, then press [ ].
- Press and hold SHIFT, then press the number buttons to jump to the desired option.
- When playing a CD**  
1 Press [ ] DISPLAY during playback. The selection display appears on the TV screen.
- Press and hold SHIFT, then press the number buttons to select the desired track.
- When playing an audio file/JPEG image file/video file**  
1 Press [ ] DISPLAY during playback. The selection display appears on the TV screen.
- Press and hold SHIFT, then press the number buttons to select the desired file.

### To play in programmed order

- Select the tracks to play in the order you want (only for CD-DA discs). A maximum of 20 tracks can be programmed.
- Press PROGRAM. The Program Menu display appears on the TV screen.

- Press and hold SHIFT, then press the number buttons to enter a 2-digit track number for the track selection ("02" for track 2, for example).
- Press [ ]/[ ]/[ ] to select [Start] to play the program.

### To play repeatedly/shuffle, etc.

- Press REPEAT repeatedly to select the desired playback mode.**  
The selected mode appears on the display.
  - "REP CHP": Repeats the current chapter.
  - "REP ALL": Repeats all titles.
  - "REP TRK": Repeats the current track.
  - "REP OFF": The system returns to normal playback mode.
  - "SHUFFLE": Plays all tracks/chapters/files only once in random order.
  - "SHUF REP": Repeats shuffle play.
  - "FOLDER": Plays the current folder.
  - "RANDOM": Repeatedly plays a randomly selected file from the current folder. In this mode, the same file may be played more than once.
  - "SINGLE": Plays the current file.
  - "REP ONE": Repeats the current file.
  - "REP FLD": Repeats the current folder.

**Note**  
The selectable modes and their order differ depending on the disc or file.

## To view information about the disc/file

You can check the playing time and remaining time of the current title, chapter, track. You can also check the time information during playback of video files.

**Press TIME repeatedly during playback.** Each time you press the button, the displayed item changes. Displayable items vary depending on the playback source.

17

### ■ [Last Memory]

This system recalls the point where you stopped the disc the last time it was played and resumes playback from that point the next time you insert the same disc.  
[On]: The system stores the resume points in memory.  
[Off]: The system does not store the resume points in memory. Playback restarts at the resume point only for the current disc in the unit.

### Note

When the resume playback memory is full, the resume playback point for the earliest disc is deleted.

### ■ [Auto Standby] (DVD/CD and USB functions only)

[On]: Enters standby mode automatically when in stop, pause, no disc, or eject mode for more than 30 minutes.  
[Off]: The unit does not enter standby mode automatically.

## Video Setup Page

### ■ [Progressive]

You can set the progressive signal that is output from the COMPONENT VIDEO OUT jack.  
The default setting is underlined.  
[On]: Turns on the progressive scan mode. Follow the instructions on the display.  
[Off]: Turns off the progressive scan mode and outputs the interlaced signal with the interlaced scan mode.

21

## Sound

### There is no sound.

- Press VOLUME + repeatedly (or turn VOLUME control on the unit clockwise) to adjust the volume.
- Make sure the headphones are not connected.
- Check the speaker connections.
- The system is in pause mode or in slow-motion play mode. Press ► to return to normal playback.
- There is severe hum or noise.**
  - Move the system away from the source of noise.
  - Connect the system to a different wall outlet.
  - Install a noise filter (commercially available) to the power cord.
- There is no microphone sound.**
  - Press VOLUME + repeatedly (or turn VOLUME control on the unit clockwise) to adjust the speaker volume.
  - Press MIC LEVEL, then press  $\blacklozenge$  to adjust the microphone volume.
  - Make sure the microphone is connected to MIC jack correctly.
  - Make sure the microphone is turned on.

**The sound loses stereo effect when you play a VIDEO CD or CD.**  
Set the audio setting to [Stereo] by pressing AUDIO.

25

## Adjusting the Sound

### To generate more dynamic sound

**Press DSGX on the unit repeatedly during playback to turn on or off the DSGX (Dynamic Sound Generator X-tra) function.**

- The default setting is underlined.
- "DSGX ON": Generates more dynamic sound.
- "DSGX OFF": Turns off the DSGX function.

### To select an equalizer setting

**Press EQ repeatedly during playback until the desired mode appears on the display.**

- The default setting is underlined.
- "ROCK": Enhanced low and high range for great sounding movie effects and atmosphere. Great for action movies and rock music.
- "JAZZ": Clear mid and high range. Recreates the atmosphere of a live club with music and watching dramas.
- "CLASSIC": Ideal for listening to classical music and watching live concert DVDs.
- "FLAT": Flat and pure sound mode.

17

## Preference Page

### ■ [TV Type]\*

[PAL]: For a PAL-system TV.  
[Multi]: For a TV that is compatible with both PAL and NTSC.  
[NTSC]: For an NTSC-system TV.

### ■ [Audio]

You can select the preferred audio language for DVDs with multiple sound tracks.

### ■ [Subtitle]

You can select the language of the subtitles recorded on a DVD VIDEO.

### ■ [Disc Menu]

You can select the language for a disc's menu.

### ■ [Parental]

You can restrict playback of DVDs that have ratings. Scenes may be blocked or replaced with different scenes.

- Press  $\blacklozenge$  to select a rating level from [1] to [8] or [Off], then press  $\odot$ .
- Press the number buttons to enter your 6-digit password.

### ■ [Default]

You can reset all the setup menu options and your personal settings to the factory defaults, except for your password for the [Password] and [Parental] items.

Press  $\odot$  to confirm the default reset.

21

## Operation

### Radio stations cannot be tuned in.

Check that the antenna is connected securely. Adjust the antenna or connect an external antenna if necessary.

### A disc does not play.

- The region code on the DVD does not match the system.
- Moisture has condensed inside the unit and may cause damage to the lenses. Remove the disc and leave the unit turned on for about half an hour.

### A DATA CD/DATA DVD cannot be played.

- The DATA CD is not recorded in ISO 9660 Level 1/Level 2 or Joliet.
- The DATA DVD is not recorded in UDF (Universal Disk Format).

### A JPEG image file cannot be played.

It is larger than 2,048 (width) × 1,536 (height) pixels in normal mode, or more than 2,000,000 pixels in progressive format which is mainly used on the Internet websites.

### A video file cannot be played.

The video file is larger than 720 (width) × 576 (height) pixels.

### The name of a folder or file is not displayed correctly.

The system can only display numbers and letters of the alphabet. Other characters are displayed as " \_".

25

## Singing along: Karaoke

You can sing along with the music by connecting an optional microphone.

- Connect an optional microphone to the MIC jack on the unit.  
"MIC ON" appears on the display.
- Press MIC LEVEL.
- Press  $\blacklozenge$  to adjust the microphone volume.
- Start playing the music and adjust the volume.

### ■ After you have finished

Adjust the microphone volume to "MIC 0" and disconnect the microphone from the MIC jack.

### ■ To adjust the microphone echo level

- Press ECHO in "MIC ON" mode.
- Press  $\blacklozenge$  to adjust echo effect.

### Note

The microphone function ("MIC ON" mode) is not available when selecting the AUDIO IN or tuner function.

18

## Password Setup Page

### ■ [Password]

The default password is "000000". To change the password:

- Press and hold SHIFT, and then enter "000000" or your last set 6-digit password in the [Old Password] section.
- Press and hold SHIFT, and then enter a new 6-digit password in the [New Password] section.
- Press and hold SHIFT, and then enter a new 6-digit password again in the [Confirm PWD] section to confirm your entry.
- Press  $\odot$  to exit the menu.

22

### A disc does not start playing from the beginning.

- Resume play has been selected. During stop, press  $\blacksquare$  (or CANCEL  $\blacksquare$  on the unit) and then start playback.
- Program play has been selected. During stop, press  $\blacksquare$  (or CANCEL  $\blacksquare$  on the unit) and then start playback.
- Shuffle play has been selected. During stop, press  $\blacksquare$  (or CANCEL  $\blacksquare$  on the unit) and then start playback.

### A disc cannot be ejected and "LOCKED" appears on the display.

Contact your Sony dealer or local authorized Sony service facility.

**The system does not work normally.**  
Disconnect the AC power cord from the wall outlet, then reconnect after several minutes.

## USB device

### The USB device (audio file/JPEG image file/video file) cannot be played.

- Files that are encrypted or protected by passwords, etc., cannot be played.
- There is no playable file on the USB device.

25

## Using a Tuner

### To preset radio stations

You can preset up to 20 FM stations and 10 AM stations. You can then tune to any of those stations simply by selecting the corresponding preset number.

- Press FUNCTION repeatedly to select "FM" or "AM."
- Press and hold TUNING +/- for 2 seconds to start tuning until you find the desired radio station.  
"SEARCH +" or "SEARCH -" appears on the display until a radio station with sufficient signal strength is found.
- Press PROGRAM.  
"P 01" flashes in the display.
- Press PRESET +/- (or press and hold SHIFT, then press the number buttons) to select a preset number.
- Press  $\odot$  to store the station frequency.

18

## Precautions

### On placement

- At high volume, over long periods of time, the cabinet becomes hot. This is not a malfunction. However, touching the cabinet should be avoided. Do not place the system in a confined space where ventilation is poor as this may cause overheating.

- Do not install the system near heat sources such as radiators or air ducts, or in a place subject to direct sunlight, excessive dust, mechanical vibration, or shock.

- Do not install the system in an inclined position. It is designed to be operated in a horizontal position only.

- Do not place heavy objects on the system.

### On operation

- If the system is brought directly from a cold to a warm location, or is placed in a very damp room, moisture may condense on the lenses inside the unit. Should this occur, the system may not operate properly. In this case, remove the disc and leave the system turned on for about half an hour until the moisture evaporates.
- If anything falls into the cabinet, unplug the unit and have it checked by qualified personnel before operating it any further.

22

## Specifications

### Main unit

#### Amplifier section

Power output (rated):  
18 watts + 18 watts (6 ohms at 1 kHz, 1% THD)  
Continuous RMS power output (reference):  
22.5 watts + 22.5 watts (6 ohms at 1 kHz, 10% THD)

#### Inputs

AUDIO IN (3.5 mm stereo mini jack):  
Impedance 10 kilohms  
MIC (monaural mini jack):  
Impedance 10 kilohms

#### Outputs

VIDEO OUT:  
Load impedance 75 ohms  
COMPONENT VIDEO OUT  
Y: 75 ohms  
Pb: 75 ohms  
Pr: 75 ohms  
PHONES (stereo mini jack):  
Accepts headphones with an impedance of 32 ohms or more  
SPEAKERS:  
Accepts impedance of 6 ohms  
(USB) port: Type A  
Maximum current: 500 mA

30

## To listen to a preset radio station

- Press FUNCTION repeatedly to select "FM" or "AM."
- Press PRESET +/- (or press and hold SHIFT, then press the number buttons) to select a preset number.
- Press VOLUME +/- or turn VOLUME control on the unit to adjust the volume.

### Tips

- When an FM stereo program has static noise, press AUDIO repeatedly to select "MONO." You will loose stereo effect, but reception will improve.
- When an AM program has static noise, press AUDIO repeatedly to improve the reception.

### To change the AM tuning interval

You can change the tuning interval, 9 kHz or 10 kHz, for AM reception by pressing and holding ► for 5 seconds when using the AM function. Please note that changing the tuning interval erases all the AM station presets.  
To reset the interval to the factory preset (9 kHz), repeat the procedure.

19

### On cleaning

Clean the cabinet, panel, and controls with a soft cloth slightly moistened with a mild detergent solution. Do not use any type of abrasive pad, scouring powder, or solvent such as alcohol or benzine.

If you have any questions or problems concerning your system, please consult your nearest Sony dealer.

### On cleaning discs, disc/lens cleaners

Do not use cleaning discs or disc/lens cleaners (including wet or spray types). These may cause the apparatus to malfunction.

### On your TV's color

**IMPORTANT NOTICE**  
Caution: If you leave the same image (a still video image, an on-screen display image, etc.) displayed on your TV for an extended period of time, you risk permanent damage to your television screen. Projection televisions are especially susceptible to this.

### On moving the system

Before moving the system, make sure that there is no disc inserted, and remove the AC power cord from the wall outlet.

### On handling discs

- To keep the disc clean, handle the disc by its edge. Do not touch the surface.
- Do not attach paper or tape to the disc.
- Do not expose the disc to direct sunlight or heat sources such as hot air ducts, or leave it in a car parked in direct sunlight as the temperature may rise considerably inside the car.

23

### Disc player section

System:  
Compact disc and digital audio and video system  
Laser Diode Properties  
Emission Duration: Continuous  
Laser Output\*: Less than 1000  $\mu$ W

- \* This output is the value measurement at a distance of 200 mm from the objective lens surface on the Optical Pick-up Block with 7 mm aperture.

Video color system format: NTSC/PAL

### USB section

(USB) port:  
Maximum current: 500 mA

### Tuner section

FM stereo, FM/AM superheterodyne tuner

### FM tuner section

Tuning range:  
87.5 MHz — 108.0 MHz (50 kHz step)  
Antenna: FM lead antenna  
Antenna terminals:  
75 ohms unbalanced  
Intermediate frequency:  
10.7 MHz

### AM tuner section

Tuning range:  
531 kHz — 1,602 kHz (9 kHz step)  
530 kHz — 1,610 kHz (10 kHz step)  
Antenna: AM loop antenna  
Antenna terminals:  
External antenna terminal  
Intermediate frequency:  
450 kHz

31

## Convenient Functions

### Using the Sleep Timer

You can set the system to turn off at a preset time, so you can fall asleep listening to music.

### Press SLEEP repeatedly.

Each time you press this button, the minute display (the remaining time) changes by 10 minutes.  
A countdown will start from the last 20 seconds before the system turns off.

### ■ To check the remaining time

Press and hold SLEEP for 3 seconds. The remaining time until the system turns off appears on the display.

### ■ To cancel the sleep timer function

Press SLEEP repeatedly until "OFF" appears on the display.

### To change the brightness of the display

The brightness of the display can be selected from 2 levels.  
The default setting is underlined.

### Press DIMMER repeatedly.

- "DIM OFF": Bright.
- "DIM ON": Dark.

19

## Using the Setup Display

You can make various adjustments to menu items.

The default setting is underlined.

- Press FUNCTION repeatedly to select the DVD/CD or USB function.  
The setup menu appears.
- Press SETUP in stop mode.  
The setup menu appears.
- Press  $\blacklozenge$  to select one of the setup menu categories, then press  $\odot$ .
- Press  $\blacklozenge$  to select a setup item, then press  $\blacklozenge$  or  $\odot$ .
- Select the option you want to change and press  $\odot$  to confirm and go back to the previously selected item.
- Press SETUP to turn off the menu.

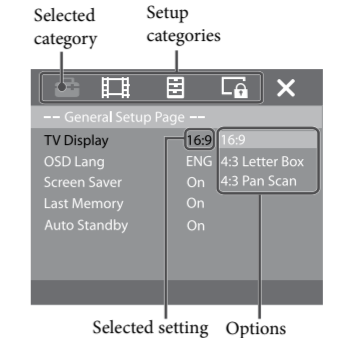

20

## Troubleshooting

If you experience any of the following difficulties while using the system, check this troubleshooting guide to help remedy the problem before requesting repairs. Should any problem persist, consult your nearest Sony dealer.  
Note that if service personnel changes some parts during repair, these parts may be retained.

### Power

**The power is not turned on.**  
Check that the AC power cord is connected securely.

### Picture

#### There is no picture.

- The video connecting cords are not connected securely.
- The unit is not connected to the correct TV input jack.
- The system is not selected via the video input of the TV.
- Check the output method on your system.
- Make sure you connect the system and your TV using the video cord (supplied) so that you can view the pictures.
- When connecting your TV and the VIDEO OUT jack of the system using the video cord (supplied), set the system to interlaced format.
- You have set to progressive format but your TV cannot accept the signal in progressive format.

24

### Supplied accessories:

- Remote Commander (1)
- AM loop antenna (1)
- FM lead antenna (1)
- Video cord (1)
- Speaker pads (8)
- Antenna isolator (1)

Design and specifications are subject to change without notice.

Standby power consumption: 0.5 W

Please contact the following to obtain customer support for this system.  
Sony China Customer Support Center  
TEL: 400-810-9000  
<http://www.sony.com.cn/>

25

## General Setup Page

### ■ [TV Display]

[16:9]: Select this when you connect a wide-screen TV or a TV with a wide mode function.

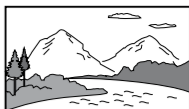

[4:3 Letter Box]: Displays a wide picture with black bands on the top and bottom.



[4:3 Pan Scan]: Displays a full-height picture on the entire screen, with trimmed sides.

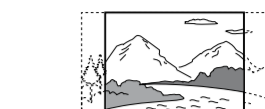

### ■ [OSD Lang] (On-Screen Display)

You can select the display language on the TV screen.

### ■ [Screen Saver]

[On]: Turns on the screen saver when in stop, pause, no disc, or eject mode for more than 15 minutes.  
[Off]: Turns off the screen saver.

20

• You have set to progressive format (525p/625p) but your TV is unable to receive signals in this format. In this case, connect your TV and the VIDEO OUT jack of the system and set to interlaced scan mode. See "[Progressive]" (page 21).

**Even though you set the aspect ratio in [TV Display] of [General Setup Page], the picture does not fill the TV screen.**

**Color irregularity occurs on the TV screen.**

The system's speakers contain magnet parts, so magnetic distortion may occur. When color irregularity occurs on the TV screen, check the following items.

— Install the speakers at least 0.3 meters from your TV set.

— If the color irregularity persists, turn off the TV set once, then turn it on after 15 to 30 minutes.

— Reposition the speakers farther away from your TV set.

**The [TV Type] setting does not match your TV.**

[TV Type] can be reset according to the following procedure:

- Press  $\blacklozenge$  to remove the disc.
- Press  $\square$  DISPLAY.
- Press  $\odot$ .

[TV Type] will be reset.

24

32